

◆ PRECISION INSTRUMENTS FOR TEST AND MEASUREMENT ◆

**Operation Manual**  
**MODEL**  
**1616 Capacitance Bridge**  
**1621 Capacitance Measuring System**

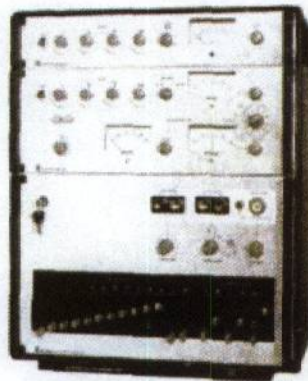

© Copyright- 2001 IET Labs, Inc.



**IET LABS, INC.**

534 Main Street, Westbury, NY 11590

www.ietlabs.com  
TEL: (516) 334-5959 • (800) 899-8438 • FAX: (516) 334-5988

VIIIM-700/cover.p65

Operation Manual  
MODEL  
1021 Capacitance Measuring System  
1021 Capacitance Measuring System

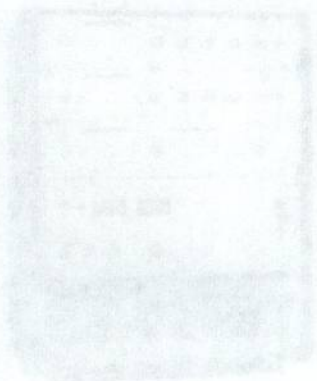

© Copyright 2004 LET Labs, Inc.

LET LABS, INC.

10000 W. 10th Street, Suite 100, Westminster, CO 80040



Tel: (303) 426-3333 • Fax: (303) 426-3333 • www.letlabs.com

1021-001



# IET LABS, INC.

534 Main Street, Westbury, NY 11590

Tel (516) 334-5959 (800) 899-8438 Fax (516) 334-5988 <http://www.ietlabs.com>

## Manual & Programmable Standards, Substituters, & Test Instruments

- New Products
- Find a Product
- Technical Applications
- Request a Quote
- Price List
- Place an Order
- Request a Catalog
- Contact Us
- About IET

If you need products or service by Genrad, esi, Biddle, or others.

**STANDARDS, DECADES STROBES**

Formerly Manufactured By:  
**QuadTech/GenRad(General Radio)**

*Now being manufactured, serviced, calibrated, and fully supported by IET LABS*

**COST-EFFECTIVE QUALITY STANDARD OR CUSTOM SOLUTION**  
**R-L-C•RTD•VOLTAGE**  
**CURRENT•PROCESS CONTROL**

Product Area of Interest

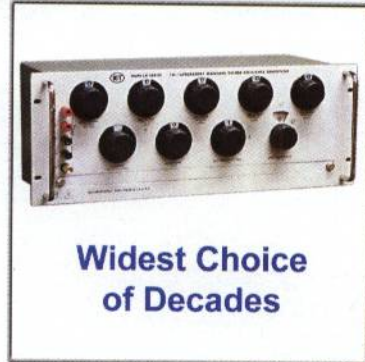

**Widest Choice of Decades**

IET is compliant with ISO 9001, ISO/IEC 17025, ANSI Z540-1-1994, and MIL-STD-45662A

## Calibration Test Measurement Metrology

[Find a Products](#) | [Technical Applications](#) | [Request a Quote](#) | [Place an Order](#) | [Free Offer](#) | [Request a Catalog](#) | [Contact Us](#)

© Copyright 1999 - 2001 IET Labs, Inc. All rights reserved.  
Problems or Comments? Contact [webmaster@ietlabs.com](mailto:webmaster@ietlabs.com)

### To navigate our easy to use website for quick access to specifications and prices:

1. Select **Find a Product** to go to a convenient scrolling thumbnail catalog and then to detailed data sheets as desired; or:
2. Select **STANDARDS DECADES STROBES** for products formerly manufactured by **GenRad (General Radio)** or **QuadTech**.

Since 1976, IET labs has had a long-standing commitment to **conform the instruments and standards we offer to the customer's needs** rather than to have the customer settle for what is available. We devote our customer service and applications entirely to the customer's satisfaction in the quality standards, test instruments and calibration service we provide.

- Combinations of functions, special ranges, ratings, or accuracies.
- Replacement for discontinued models from other manufacturers.
- Calibration and repair services - NIST traceable.
- Compliant with ISO 9001, ISO 17025, ANSI Z540-1-1994, and MIL-STD-45662A.

#### Capabilities

- R: 20  $\mu\Omega$ -1 T $\Omega$
- C: <1 pF - 1 F
- L: 100  $\mu$ H-100 H

- Accuracy to 1 ppm
- Resolution to 0.1 ppm
- Voltage to 20 kV
- Power to over 1000 W
- Programmable IEEE-488 or BCD



*The World Standard in Metrology*  
**Since 1915**  
 Now continuing the *GenRad* tradition

Featuring instruments formerly  
 manufactured by  
**GenRad/General Radio/QuadTech**



# WARRANTY

We warrant that this product is free from defects in material and workmanship and, when properly used, will perform in accordance with applicable IET specifications. If within one year after original shipment, it is found not to meet this standard, it will be repaired or, at the option of IET, replaced at no charge when returned to IET. Changes in this product not approved by IET or application of voltages or currents greater than those allowed by the specifications shall void this warranty. IET shall not be liable for any indirect, special, or consequential damages, even if notice has been given to the possibility of such damages.

THIS WARRANTY IS IN LIEU OF ALL OTHER WARRANTIES, EXPRESSED OR IMPLIED, INCLUDING BUT NOT LIMITED TO, ANY IMPLIED WARRANTY OF MERCHANTABILITY OR FITNESS FOR ANY PARTICULAR PURPOSE.



## WARNING



OBSERVE ALL SAFETY RULES  
WHEN WORKING WITH HIGH VOLTAGES OR LINE VOLTAGES.

**Dangerous voltages may be present inside this instrument. Do not open the case  
Refer servicing to qualified personnel**

### HIGH VOLTAGES MAY BE PRESENT AT THE TERMINALS OF THIS INSTRUMENT

WHENEVER HAZARDOUS VOLTAGES (> 45 V) ARE USED, TAKE ALL MEASURES TO  
AVOID ACCIDENTAL CONTACT WITH ANY LIVE COMPONENTS.

USE MAXIMUM INSULATION AND MINIMIZE THE USE OF BARE  
CONDUCTORS WHEN USING THIS INSTRUMENT.

**Use extreme caution when working with bare conductors or bus bars.**

WHEN WORKING WITH HIGH VOLTAGES, POST WARNING SIGNS AND  
KEEP UNREQUIRED PERSONNEL SAFELY AWAY.



## CAUTION



DO NOT APPLY ANY VOLTAGES OR CURRENTS TO THE TERMINALS OF THIS  
INSTRUMENT IN EXCESS OF THE MAXIMUM LIMITS INDICATED ON  
THE FRONT PANEL OR THE OPERATING GUIDE LABEL.



# Table of Contents

Section	Page	Section	Page
<b>CONDENSED OPERATING INSTRUCTIONS</b>	ix		
<b>SPECIFICATIONS</b>	x		
<b>1 INTRODUCTION</b>			
1.1 Purpose	1-1		
1.2 Description	1-1		
1.2.1 General	1-1		
1.2.2 Bridge Circuit	1-1		
1.2.3 Standards	1-2		
1.2.4 Oscillator	1-2		
1.2.5 Detector	1-2		
1.3 Controls, Indicators, and Connections	1-3		
1.4 Accessories	1-3		
<b>2 INSTALLATION</b>			
2.1 General	2-2		
2.2 Dimensions	2-3		
2.3 Environment	2-2		
2.4 Bench Models	2-2		
2.4.1 Cabinet Removal	2-2		
2.4.2 Conversion For Rack Mounting	2-2		
2.5 Rack Models	2-2		
2.5.1 General	2-3		
2.5.2 Installation	2-3		
2.5.3 Conversion To Bench Use	2-3		
2.6 Power-Line Connection	2-4		
2.7 Line-Voltage Regulation	2-4		
2.8 System Connections	2-4		
2.8.1 Oscillator, Bridge, and Detector	2-4		
2.8.2 BCD-Capacitance-Output Connector	2-4		
2.8.3 BCD-Conductance-Output Connector	2-5		
2.8.4 Analog Outputs	2-5		
<b>3 OPERATION</b>			
3.1 Preliminary Checks	3-1		
3.2 Functional Self-Checks	3-1		
3.3 Phase Adjustment	3-2		
		3.4 Connection of Unknown Capacitor	3-3
		3.4.1 Three-Terminal Capacitors	3-3
		3.4.2 Two-Terminal Coaxial Capacitors	3-3
		3.5 Balance and Readout	3-4
		3.5.1 Readout Multiplier	3-4
		3.5.2 Initial Settings of Lever Switches	3-5
		3.5.3 Balance Procedures	3-5
		3.5.4 Final Balance	3-6
		3.5.5 Readout Correction	3-7
		3.5.6 Units of Measurement	3-7
		3.6 Parameters of The Unknown Capacitor	3-7
		3.6.1 Series Equivalent Parameters	3-7
		3.6.2 Dissipation Factor	3-8
		3.7 Frequency	3-8
		3.7.1 Setting The Frequency	3-8
		3.7.2 Monitoring Frequency	3-8
		3.7.3 Locking To a Frequency Reference	3-10
		3.8 Voltage Level	3-10
		3.9 Accuracy	3-10
		3.9.1 Accuracy Versus Frequency and Cx	3-10
		3.9.2 Accuracy Versus Temperature	3-11
		3.9.3 Range and Dissipation Factor Limitations	3-12
		3.9.4 Shunt Capacitance To Ground	3-12
		3.9.5 Fringing Capacitance	3-13
		3.9.6 Conductance Accuracy	3-14
		3.10 Precision	3-15
		3.11 External Standards	3-15
		3.11.1 Range Extension To 111 Microfarads	3-15
		3.11.2 Extension of C Resolution	3-16
		3.11.3 Externally Determined Accuracy/Comparisons	3-16

# Table of Contents (Cont'd)

Section	Page	Section	Page
3.11.4	Test-Fixture Compensation . 3-17	4.6	G-Standards Accuracy . . . . . 4-9
3.11.	5 Range Extensions To 11 Microsiemens . . . . . 3-17	4.7	Ratio Accuracy . . . . . 4-11
3.12	Precise Comparisons . . . . . 3-17	4.7.1	Residual Impedances . . . . . 4-11
3.12.1	Balance Comparisons . . . . . 3-17	4.7.2	Example With 1:1 Ratio . . . . . 4-12
3.12.2	Direct Substitution . . . . . 3-17	4.7.3	The 10:1 Ratio . . . . . 4-13
3.13	Non-coaxial 2-Terminal Capacitors . 3-17	4.7.4	The 1:100 Ratio . . . . . 4-13
3.13.1	Unshielded 2-Terminal Capacitors . . . . . 3-18	4.7.5	C Offset Due To Induction . 4-14
3.13.2	Shielded 2-Terminal Capacitors . . . . . 3-18	4.7.6	Ground Circuit Impedance . 4-14
3.14	Dc Bias . . . . . 3-20	<b>5 SERVICE and DIAGRAMS</b>	
3.14.1	Normal Bridge Configuration/ Parallel Bias . . . . . 3-21	5.1	GR Field Service . . . . . 5-1
3.14.2	Reversed Bridge Configuration/ Series Bias . . . . . 3-21	5.2	Minimum Performance Standards . 5-1
3.14.3	Dc In The Ratio Transformer/ Demagnetization . . . . . 3-22	5.2.1	General . . . . . 5-1
3.15	Reversed Configuration . . . . . 3-22	5.2.2	Zero Setting, Offsets, and Sensitivity . . . . . 5-3
3.15.1	Explanation . . . . . 3-22	5.2.3	Capacitance Accuracy . . . . . 5-3
3.15.2	Procedure . . . . . 3-22	5.2.4	Capacitance Ratios . . . . . 5-3
<b>4 THEORY</b>		5.2.5	Conductance Accuracy . . . . . 5-3
4.1	Introduction . . . . . 4-1	5.2.6	Conductance Multipliers . . . 5-4
4.2	Properties of Capacitors . . . . . 4-1	5.3	Dissassembly . . . . . 5-5
4.2.1	Basic Components of Capacitance . . . . . 4-1	5.3.1	Knobs . . . . . 5-5
4.2.2	Inductive and Lossy Components . . . . . 4-2	5.3.2	Cabinet Removal . . . . . 5-5
4.2.3	Frequency Characteristics . . 4-4	5.3.3	C-Box Removal . . . . . 5-5
4.3	Basic Bridge Circuitry . . . . . 4-5	5.3.4	The G Box . . . . . 5-7
4.3.1	Elementary Capacitance Bridges . . . . . 4-5	5.4	Recalibration and Adjustments . . . 5-7
4.3.2	Transformer-Ratio Bridges . 4-5	5.4.1	Internal Capacitance Standards . . . . . 5-8
4.4	Circuitry of The 1616 Bridge . . . . . 4-7	5.4.2	Conductance Multipliers . . . 5-8
4.4.1	Excitation . . . . . 4-7	5.4.3	C301/Setting Zero C . . . . . 5-8
4.4.2	Circuit For The Unknown . . . 4-7	5.4.4	Lever-Switch Stiffness . . . . 5-8
4.4.3	Capacitance Standards . . . . 4-7	5.4.5	Maintenance Note On Switches . . . . . 5-8
4.4.4	Conductance Standards . . . . 4-8	5.5	Trouble Analysis . . . . . 5-9
4.4.5	External Standards . . . . . 4-9	5.5.1	Mechanical Damage . . . . . 5-9
4.4.6	Zero Adjust . . . . . 4-9	5.5.2	BCD Circuits . . . . . 5-9
4.5	C-Standards Accuracy . . . . . 4-9	5.5.3	Non-Repairable Subassemblies . . . . . 5-9
4.5.1	Calibration . . . . . 4-9	5.5.4	Typical Parameters . . . . . 5-9
4.5.2	Sealing . . . . . 4-10	5.6	Parts Lists and Diagrams . . . . . 5-9
4.5.3	Thermal Lag . . . . . 4-10	<b>APPENDIX A AN INTERPRETATION of MILLEA'S METHOD TO ELIMINATE FRINGING FROM TWO- TERMINAL MEASUREMENT . . . . . A-1</b>	



# List of Illustrations

Figure	Title	Page
---	1621 Precision Capacitance-Measurement System .....	ii
---	1616 Precision Capacitance Bridge .....	x
1-1	Elementary Diagram, 1621 Precision Capacitance-Measurement System-GR1616 Bridge with 1316 Oscillator and 1238 Detector .....	1-2
1-2	Front-Panel Controls, Indicators, and Connectors of the 1621 Precision Capacitance-Measurement System .....	1-3
1-3	Rear-Panel Controls, Connectors, and Cables .....	1-7
2-1	Dimensions of the Bench Models .....	2-1
2-2	Dimensions of the Rack Models .....	2-1
2-3	Bench-Cabinet Installation .....	2-2
2-4	Rack-Cabinet Installation .....	2-3
2-5	Terminal Identification at BCD CAPACITANCE OUTPUT Connector (A-J13, Rear Panel of Bridge) .....	2-5
2-6	Terminal Identification at BCD CONDUCTANCE OUTPUT Connector (A-J12, Rear Panel of Bridge) .....	2-5
2-7	DC Meter Outputs Socket on 1238 Detector, Exterior (Rear) View .....	2-6
3-1	Simplified Bridge Diagram 3-Terminal Connection of Unknown Capacitor .....	3-3
3-2	Simplified Bridge Diagram 2-Terminal Connection of Unknown Capacitor .....	3-4
3-3	The 1621 Capacitance-Measurement System Simplified Diagram .....	3-5
3-4	Equivalent Circuits of the Unknown Capacitor .....	3-8
3-5	Dissipation Factor Versus Directly Measured Parameters .....	3-9
3-6	Specified Capacitance Accuracy of the 1616 Bridge .....	3-11
3-7	Worst-Case Measurement Error Due to Temperature (Based on Maximum Temp Coef of C Stds) .....	3-12
3-8, 3-9	Non-Coaxial 2-Terminal Capacitors and Some Measurement Configurations .....	3-19
3-10	Circuit For Applying Bias To The Unknown Capacitor-Normal Configuration .....	3-21
3-11	Reversed Configuration - Bridge Circuit With Oscillator and Detector Interchanged .....	3-22
4-1	Schematic Diagram of a Capacitor .....	4-1
4-2	Structure of a 3-Terminal Capacitor With 2 Coaxial Connectors .....	4-1
4-3	A Coaxial 2-Terminal Capacitor, It's Structure, Component Capacitance, and Connection To a Bridge .....	4-2
4-4	Capacitor Lumped-Parameter Equivalent Circuits and Vector Diagrams .....	4-3
4-5	Capacitance Versus Frequency Characteristic of a Mica Capacitor .....	4-4
4-6	Dissipation Factor Versus Frequency Characteristics of a Mica Capacitor .....	4-5
4-7	An Elementary Capacitance Measuring Bridge .....	4-5
4-8	An Elementary Capacitance Bridge With Transformer Ratio Arms .....	4-6
4-9	Circuitry For 3 Methods of Balancing a Transformer-Ratio Capacitance Bridge .....	4-6
4-10	Simplified Bridge Schematic Diagram .....	4-11

---

## List of Illustrations (Cont'd)

---

Figure	Title	Page
5-1	Three-Terminal Conductance Standards .....	5-5
5-2	Interior View, Upper Rear, With the C-Box Removed .....	5-6
5-3	Interior Bottom View .....	5-7
5-4	Detent Mechanism of a Typical Lever Switch, A and B Constructions .....	5-9
5-5	Front View; Mechanical Replaceable Parts Identified .....	5-11
5-6	Rear View; Mechanical Replaceable Parts .....	5-11
5-7	Wiring Diagram of BCD Output Circuits .....	5-11
5-8	Conductance Multiplier Board Assembly 1616-4720 .....	5-12
5-9	Schematic Diagram of the 1616 Precision Capacitance Bridge .....	5-13
A-1	..... Test Setup For 2-Terminal Measurement, With Fringing Eliminated .....	A-1

---

## List of Tables

---

Table	Title	Page
1-1	Front-Panel Controls, Indicators, and Connectors .....	1-4
1-2	Rear-Panel Controls and Connectors .....	1-6
1-3	Accessories Supplied With the 1621 System .....	1-9
2-1	Rack-Mounting Cabinets and Brackets for 1621 System .....	2-2
2-2	Key to Screw Sizes .....	2-3
2-3	Binary-Coded Decimals (BCD) .....	2-5
2-4	Readout-Multiplier Code .....	2-5
3-1	Senses of Phase-Sensitive Meters .....	3-2
3-2	Characteristics At Bridge Detector Output Connector .....	3-21
3-3	Bias Current Limits For Transformer Saturation .....	3-22
4-1	Approximate Magnitudes of Residual Parameters .....	4-11
4-2	Error Example, Ratio 1:1 .....	4-13
5-1	Test Equipment .....	5-2
5-2	Capacitance Ratio Checks .....	5-2
5-3	Conductance Accuracy and Multiplier Checks .....	5-4

# Condensed Operating Instructions



## WARNING

Dangerous voltages may be present at the terminals of this instrument. To reduce the risk of electric shock, turn the voltage source to "O" before connecting or disconnecting device under test.

## CAUTION

Be sure the line-voltage switches on Oscillator and Detector rear panels are properly set for the available power.

## TUNING AND PHASE ADJUSTMENT.

- a. Set the controls as follows.  
POWER : ON (up) oscillator and detector  
FREQUENCY SELECTORS: as desired or 1.01kHz  
Oscillator E<sub>o</sub> RANGE: 15V  
E<sub>o</sub> ADJUST: MAX  
Detector TIME CONSTANT: 0.1s  
PUSH BUTTONS: both out  
IN-PHASE FINE ADJUST: midrange  
QUAD FINE ADJUST: midrange  
PHASE SHIFT (inner knob): 180 deg  
SENSITIVITY: full on (cw)  
Bridge TERM SELECTOR: CAL  
EXT MULT: OFF  
  
G levers X G Mult: 0 μS 000.0 nS X 10<sup>-6</sup>  
C levers: 05 pF 000 fF 000. 0 aF  
(First three digits masked)  
GAIN: 30db (or keep MAGNITUDE on scale)
- b. Fine tune oscillator to detector frequency (peak on MAGNITUDE meter). (Note 3rd osc dial is continuous).
- c. Reset C levers to 00 pF 000 fF 500 . 0 aF  
Reset GAIN to 100db  
Read just C levers for MAGNITUDE of 20-40
- d. Using PHASE SHIFT (large knob) bring QUADRATURE meter to zero.  
Reset C levers for MAGNITUDE of 80-100, reset zero using PHASE SHIFT first and then QUAD FINE ADJUST.

## NOTE

Keep MAGNITUDE meter on scale for correct phase indication; other meters may be off scale.

- e. Reset C levers to all zeros.  
Adjust G levers for MAGNITUDE of 80-100.  
Using only IN-PHASE FINE ADJ, set IN PHASE meter to zero.

## 3-TERMINAL MEASUREMENT.

a. Connect unknown capacitor between inner conductors (HIGH, LOW) of 3-term C<sub>x</sub> port, shield to outer conductor of either or both connectors. Cables are optional; shield at least the LOW one. (Cable capacitance is excluded from the measurement.)

b. Set TERM. SELECTOR to upper X1 position unless C<sub>x</sub> is larger than 1 nF (1000 pF), then use X10. If appropriate, raise C-MAX lever.

c. Set C and G levers to approximate values of C<sub>x</sub> and G<sub>x</sub> (parallel components of "unknown").

d. With GAIN control keep MAGNITUDE indication on scale. Turn SENSITIVITY and TIME CONSTANT cw, if required to achieve final balance (below). For best resolution, increase E<sub>o</sub> RANGE to 150 V.

## CAUTION

Do not exceed either 350 V rms or 0.16 f volts (example: 16 V at 100 Hz) in normal configuration.

e. Refine the balance, left-to-right with C levers, bringing IN PHASE meter toward zero until the G error predominates. Then continue with G levers, bringing QUAD meter toward zero until the C error predominates. Repeat step e until balance reaches the resolution you need.

## 2-TERMINAL MEASUREMENT.

a. Set TERMINAL SELECTOR to right X1 position unless C<sub>x</sub> is larger than 1 nF, then use X100. Raise C-MAX lever, if appropriate.

b. Set readout to value of fringing capacitance of 2-terminal port, i.e., \*\* nF \*00 pF 115 fF 000.0 aF, 0 μS 000.0 nS X 10<sup>-6</sup>, if you selected X1 in step a. If X10 or X100, set C proportionally smaller (11.5 fF or 1.15 fF, respectively).

c. Balance the bridge with ZERO ADJUST.

d. Connect unknown capacitor to the 2-TERM C<sub>x</sub> port: outer shell — ungrounded — to outer conductor of connector, inner (shielded) terminal to inner conductor.

e. Proceed as before — steps, c, d, e of the 3-terminal instructions.

## FURTHER INFORMATION.

Refer to the Table of Contents.

# Specifications

## 1616 PRECISION CAPACITANCE BRIDGE

**Capacitance measurement, 3-terminal:** DECADES: 12. RANGE: 0.1 aF to 1  $\mu$ F ( $10^{-19}$  to  $10^{-6}$  F). ACCURACY: \*  $\pm 10$  ppm, when most-significant decade is 1, 10, or 100 pF per step; otherwise, and at other frequencies, accuracy is  $\pm [50 \text{ ppm} + (0.5 + 20 C_{\mu\text{F}}) (f_{\text{MHz}})^2 \text{ ppm} + (f_{\text{MHz}}) \text{ aF}]$ .

**Capacitance, 2-terminal:** Same as above, except as follows. RANGE: One additional decade, to 10  $\mu$ F ( $10^{-19}$  to  $10^{-5}$  F).

**Conductance measurement, 3-terminal:** DECADES: 5 (virtually extended to 11 by G multiplier). RANGE: 100 aS to 100  $\mu$ S ( $10^{-10}$  to  $10^{-7}$  S). ACCURACY: \*  $\pm (0.1\% + 1 \text{ step in least significant decade})$ . There is a small reduction in conductance accuracy at frequencies other than 1 kHz. RESIDUAL C (across conductance standards):  $\pm (< 0.03 \text{ pF})$ .

**Conductance, 2-terminal:** Same as above, except as follows. RANGE: One additional decade, to 1000  $\mu$ S ( $10^{-10}$  to  $10^{-7}$  S).

**Multipliers:** FOR 3-TERM: X1, X10; FOR 2-TERM: X1, X10, X100; affect both C and G. FOR CONDUCTANCE ONLY: X1, X10<sup>-1</sup>, . . . X10<sup>-6</sup> (7 positions). Effects of these multipliers are included in the specified ranges.

**Frequency:** 10 Hz to 100 kHz.

**Standards:** CAPACITANCE: Air dielectric with TC  $< +40$  ppm/ $^{\circ}$ C and D  $< 10$  ppm for 7 lowest decades; Invar $\dagger$ , air dielectric with TC of  $+3 \pm 1$  ppm/ $^{\circ}$ C and D  $< 10$  ppm for 3 middle decades; mica dielectric with TC of  $20 \pm 10$  ppm/ $^{\circ}$ C and D  $< 200$  ppm for 2 highest decades. ADJUSTMENTS for all capacitance standards available through key-locked door on panel. THERMAL LAG: C standards for first 8 decades mounted in an insulated compartment with a thermal time constant of 6 h (time required for compartment interior to reach 63% of ambient change). CONDUCTANCE: Metal-film resistors in T networks with small phase angles.

**Comparison:** Terminals provided to connect external standard for comparison measurements; 13-position panel switch multiplies standard by  $-0.1, 0 \dots +1$ .

**Input:** The smaller of 160 f<sub>rms</sub> or 350 V rms can be applied to the bridge transformer at the GENERATOR terminal without waveform distortion; 500 V rms max, depending on conductance range, when GENERATOR and DETECTOR connections are interchanged.

**Interface:** G900 locking coaxial connector on panel to connect 2-terminal unknowns, G874 locking coaxial connectors on panel to connect 3-terminal unknowns and 2 to connect external standard. DATA OUTPUT: 50-pin and 36-pin type 57 connectors on rear provide connection to 8-4-2-1 weighted BCD contacts (rated at 28 V, 1 A) on each switch for capacitance and conductance values respectively.

OSCILLATOR and DETECTOR: Connect to rear BNC connectors.

**Required:** OSCILLATOR: GR 1316 recommended. DETECTOR: GR 1238 recommended. The 1616 Bridge is available with this oscillator and detector as the 1621 Capacitance-Measuring Assembly.

**Available:** 1316 OSCILLATOR, 1238 DETECTOR and a broad line of capacitance standards.

**Mechanical:** Bench or rack model. DIMENSIONS (wxhxd): Bench, 19.75x13.81x12.88 in. (502x351x327 mm); rack, 19x12.22x10.56 in. (483x310x268 mm). WEIGHT: Bench, 57 lb (26 kg) net, 69 lb (32 kg) shipping; rack, 49 lb (23 kg) net, 61 lb (28 kg) shipping.

\*Accuracy for these conditions: Frequency, 1 kHz, except as noted; temperature,  $23^{\circ} \pm 1^{\circ}$  C; humidity,  $< 50\%$  RH. See manual for detailed accuracy analysis.

$\dagger$  Registered trademark of the Carpenter Steel Co. G900 and G874 - Gilbert Engineering, Glendale, Arizona 85301



Description	Catalog Number
1616 Precision Capacitance Bridge	
Bench Model	1616-9700
Rack Model	1616-9701

## 1621 PRECISION CAPACITANCE-MEASUREMENT SYSTEM

**Internal Temperature:** C standards in bridge, about  $1^{\circ}$ C above ambient; for ultimate accuracy, allow 24 hrs to stabilize with ac power on.

**Frequency:** 10 Hz to 100 kHz.

**Supplied:** 1616 Precision Capacitance Bridge, 1316 Oscillator, 1238 Detector, all necessary interconnection cables, and power cord.

**Available:** 1404 REFERENCE STANDARD CAPACITORS (10 pF, 100 pF, and 1000 pF) for calibration.

**Power:** 100 to 125 and 200 to 250 V, 50 to 60 Hz, 51 W.

**Mechanical:** Bench or rack models. DIMENSIONS (wxhxd): Bench, 19.75x24.25x15 in. (502x616x381 mm); rack, 19x20.91x11.44 in. (483x531x291 mm). WEIGHT: Bench, 105 lb (48 kg) net, 140 lb (64 kg) shipping; rack, 90 lb (41 kg) net, 125 lb (57 kg) shipping.

Description	Catalog Number
1621 Precision Capacitance-Measurement System	
Bench Model, 60-Hz	1621-9701
Rack Model, 60-Hz	1621-9702
Bench Model, 50-Hz	1621-9703
Rack Model, 50-Hz	1621-9704

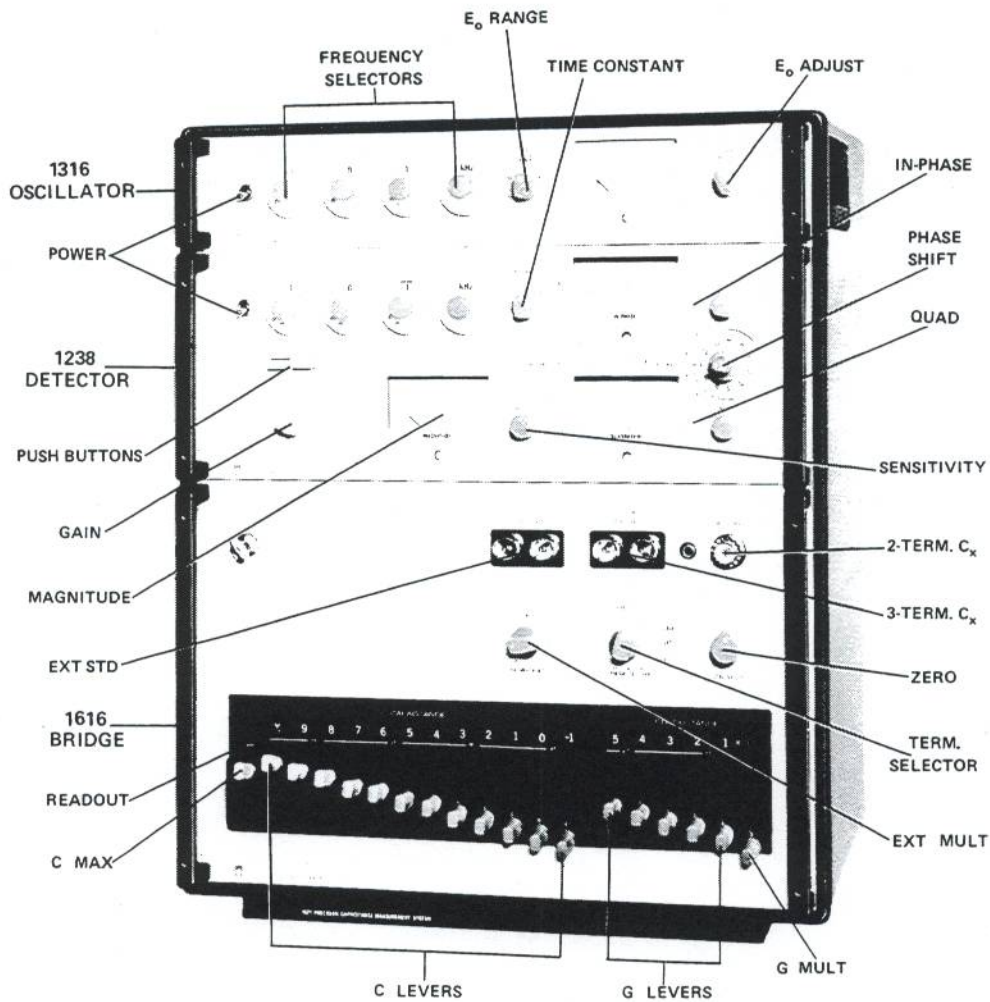

1621 Precision Capacitance-Measurement System



QuadTech warrants that Products are free from defects in material and workmanship and, when properly used, will perform in accordance with QuadTech's applicable published specifications. If within one (1) year after original shipment it is found not to meet this standard, it will be repaired, or at the option of QuadTech, replaced at no charge when returned to a QuadTech service facility.

**Changes in the Product not approved by QuadTech shall void this warranty.**

QuadTech shall not be liable for any indirect, special or consequential damages, even if notice has been given of the possibility of such damages.

This warranty is in lieu of all other warranties, expressed or implied, including, but not limited to any implied warranty or merchantability or fitness for a particular purpose.

### SERVICE POLICY

QuadTech policy is to maintain product repair capability for a period of at least five (5) years after original shipment and to make this capability available at the then prevailing schedule of charges.

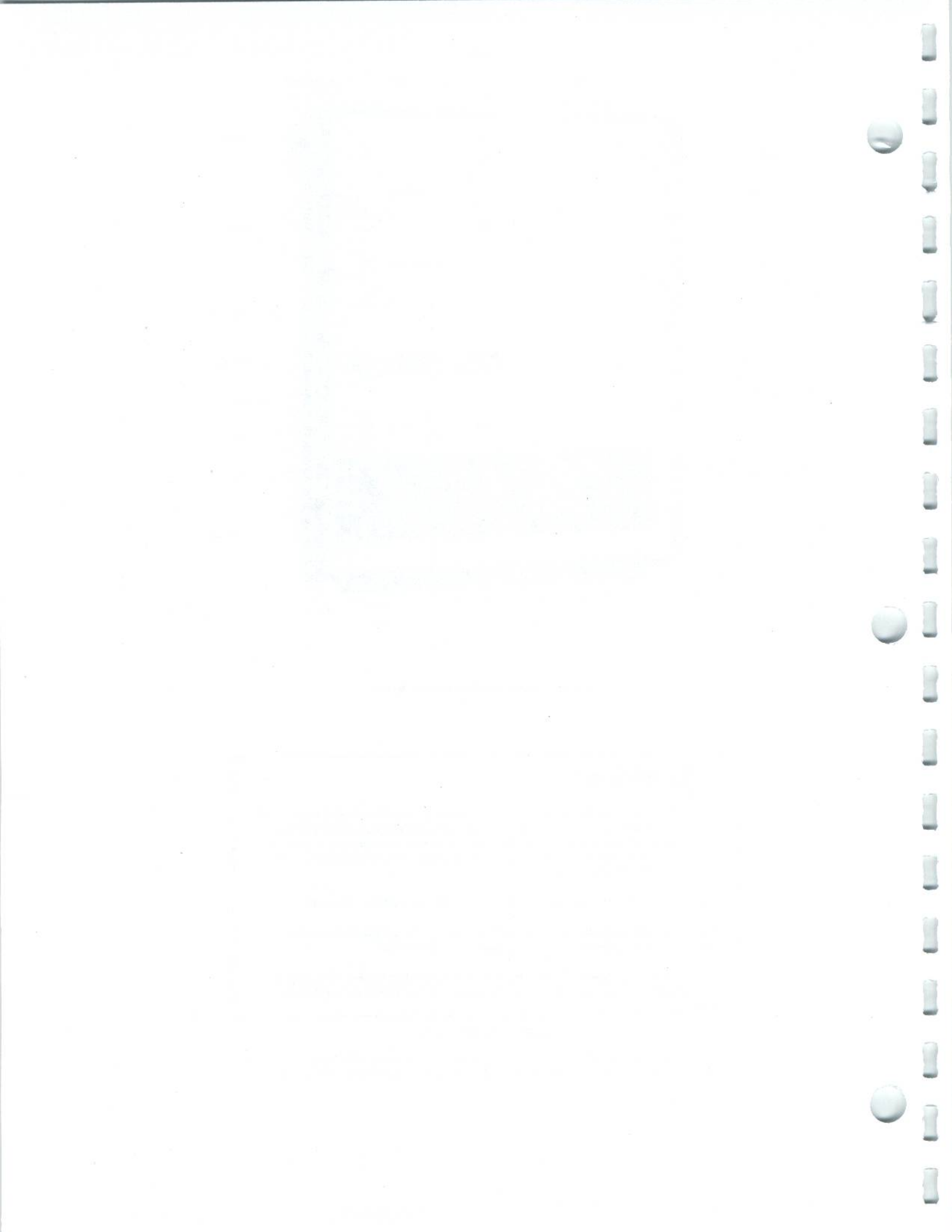

# Introduction—Section 1

1.1 PURPOSE . . . . .	1-1
1.2 DESCRIPTION . . . . .	1-1
1.3 CONTROLS, INDICATORS, AND CONNECTORS . . . . .	1-3
1.4 ACCESSORIES . . . . .	1-3

## 1.1 PURPOSE.

The 1621 Capacitance-Measurement System is designed for the precise measurement of capacitors and capacitance standards. In the standards laboratory, its high resolution for capacitance and conductance make this system well suited for capacitance standards measurements. Its phase-indicating error meters facilitate rapid balancing. Convenient in-line readout maximizes accuracy of *manual* data recording and BCD outputs are provided for *automatic* data processing.

The 1621 system measures either 3-terminal or 2-terminal capacitors. The transformer-ratio-arm circuitry of the bridge assures that 3-terminal measurements can be made accurately, even in the presence of large capacitances to ground. For instance, a ground capacitance of 1  $\mu\text{F}$  produces an error of only 0.03% in the measurement of 1000-pF capacitor. This feature makes the assembly very useful for *in situ* measurements of ungrounded circuit capacitances.

The 1616 Precision Capacitance Bridge, one of the 3 instruments in that system, may be obtained separately. The bridge will perform as described herein, if used with an oscillator and detector equivalent to the GR 1316 and 1238.

### NOTE

This manual describes the 1621 system generally and provides its operating instructions. This manual also describes in detail the 1616 bridge only.

A wide range of capacitances can be measured, extending from the resolution limit of 0.1 aF ( $10^{-7}$ pF) to a maximum of 10  $\mu\text{f}$ , with internal standards, or farther with external standards. For 3-terminal unknown capacitors, a

pair of coaxial terminals is provided; for 2-terminal coaxial "unknowns," a single precision connector facilitates exacting control of fringing effects.

Since an important use of this bridge is the comparison of capacitance standards, another pair of coaxial terminals is provided on the bridge to which a 3-terminal reference standard can be connected and designated EXTERNAL STANDARD. The other standard is then connected to the selected UNKNOWN terminals, and the internal standards are used to complete the balance. If the ratio between the two standards is close to 0.1, 1., or 10, the accuracy of the measurement is equal to the accuracy of calibration of the reference standard, and the precision of comparison is 1 part in  $10^8$  (0.01 ppm) of a 10-pF capacitor (or even better for larger ones).

## 1.2 DESCRIPTION.

Figure 1-1.

### 1.2.1 General.

The 1621 Precision Capacitance-Measurement System consists of the 1616 Precision Capacitance Bridge with the 1316 Oscillator and the 1238 Detector, a complete system for the precise measurement of capacitance.

Oscillator and detector are mounted above the bridge, in a pedestal cabinet, as pictured in the front pages (and Figure 1-2); or the three instruments may be rack mounted. Connecting cables, supplied, go neatly behind the assembly. An elementary system diagram is given in Figure 1-1.

### 1.2.2 Bridge Circuit.

The ratio arms of the bridge are transformer windings, tapped on the standard side in decimal steps (-1, 0, 1, 2...9, X) and on the unknown side in decade steps (X100, X10, X1). Separate, fixed-capacitance standards are used, whose values range in decade steps from 1 aF to 100 nF. This combination of internal standards and transformer

ratios makes possible the wide measurement range of 1 to  $10^{14}$

Loss in the measured capacitor is expressed as parallel conductance from the resolution limit of 0.1 fS to a maximum of 1 mS a measurement range of 1 to  $10^{13}$ . The values of the set of 5 conductance standards are effectively extended by series resistance standards, in 6 decade steps ( $X1 \dots X10^{-6}$ ).

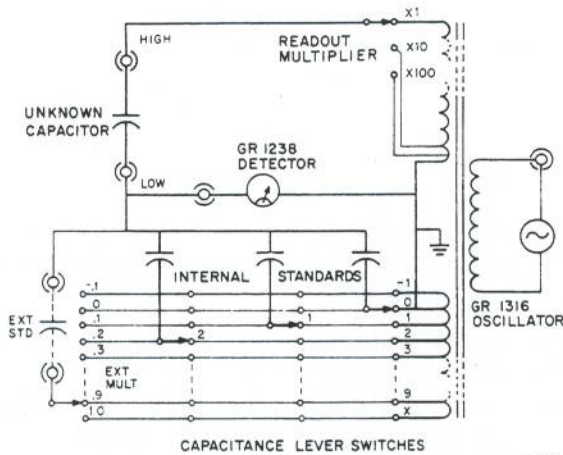

Figure 1-1. Elementary diagram, 1621 Precision Capacitance-Measurement System – GR 1616 bridge with 1316 Oscillator and 1238 Detector. Conductance circuitry is omitted.

### 1.2.3 Standards.

Internal capacitance standards are of 4 types. The 3 most stable capacitors, made with Invar\* steel, have temperature coefficients about 3 ppm per °C, and the next 3 smaller capacitors (also Invar), about 20 ppm per °C. Their nitrogen dielectric is hermetically enclosed to assure independence from effects of changing atmospheric pressure and humidity. The 2 largest standards, of sealed, low-loss mica construction, and the 4 smallest, being open air-dielectric capacitors, have temperature coefficients about 20 ppm per °C.

The set of 6 Invar and 2 mica standard capacitors are well insulated from the environment, the thermal time constant being 6 hours. So the bridge is remarkably insensitive to fluctuations of environmental temperature caused, for example, by a cycling air conditioner or the movement of personnel.

### 1.2.4 Oscillator.

The 1316 Oscillator, developed for the 1621 system, is a convenient, stable, powerful source. Set the 5 in-line decade frequency dials anywhere between 10 Hz and 100 kHz, and

you are sure of frequency within  $\pm 1\%$ . After warmup the frequency stability is typically within  $\pm 0.001\%$  for a few minutes. Set the level as desired, up to 1.6 W into a wide range of load impedances ( $0.25 \Omega$  to  $2.5 \text{ k}\Omega$ ) with the help of the front-panel meter (reading 0.1 to 125 V) and you are sure of a pure and constant output signal. Its level varies less than  $\pm 2\%$  with tuning; its distortion remains less than 0.4% over 3 decades of frequency and from open to short-circuit loading.

Auxiliary outputs are provided, both in-phase and quadrature, for detector references. These signals are comparable in quality with the main output. The level of each auxiliary output signal is about 1.3 V rms, driving the minimum recommended load impedance of  $47 \text{ k}\Omega$ . The phase separation between them is typically 87 to  $90^\circ$ , except below 50 Hz it may be a few degrees less. (FINE ADJUST controls on the 1238 Detector panel enable you to establish the desired quadrature phase *in the detector*.)

With the synchronizing circuit you can conveniently lock this oscillator to a more stable source or provide sync to a scope, counter, or another oscillator.

### NOTE

For more details about the 1316 Oscillator, refer to its instruction manual.

### 1.2.5 Detector.

The 1238 Detector, also developed for the 1621 system, complements the oscillator and bridge with convenience and sensitivity. Set the frequency dials to match those of the oscillator, or select the flat response characteristic. Set the gain as required; you can have full-scale readout for any bridge error from 70 nV (tuned response) to 400 mV (FLAT) – a range of 135 dB. Yet the instrument is immune from damage by signals as large as 200 V, at any gain setting.

Watch the in-phase and quadrature meters as you balance the bridge, they indicate conveniently whether to adjust C or G next, and whether to increase or decrease the weighting. (Convenient phase adjustments enable you to compensate for any phase shift ( $0-360^\circ$ ) through bridge, cables, and filter and to set the 2 phase-detector references exactly in quadrature.)

In addition to filter tuning, gain, and phase, front-panel controls select linear vs 20-dB-compressed response, rejection of power-line frequency components, and meter time constants from 0.1 to 10 s.

\*Registered trademark of the Carpenter Steel Co., Reading, Pa.



**NOTE**

For more details about the 1238 Detector, refer to its instruction manual.

**1.4 ACCESSORIES.**

Table 1-3 lists the accessories supplied with the 1621 Precision Capacitance Measurement System. Power cords are supplied for the 2 instruments that use them. Rack-mounting hardware is also supplied with the system, if it is the "rack" version. For mounting refer to paragraph 2.5.

**1.3 CONTROLS, INDICATORS, AND CONNECTORS.**

Figures 1-2 and 1-3 illustrate the instrument system, front and rear. Tables 1-1 and 1-2 further describe the individual controls, indicators, and connectors.

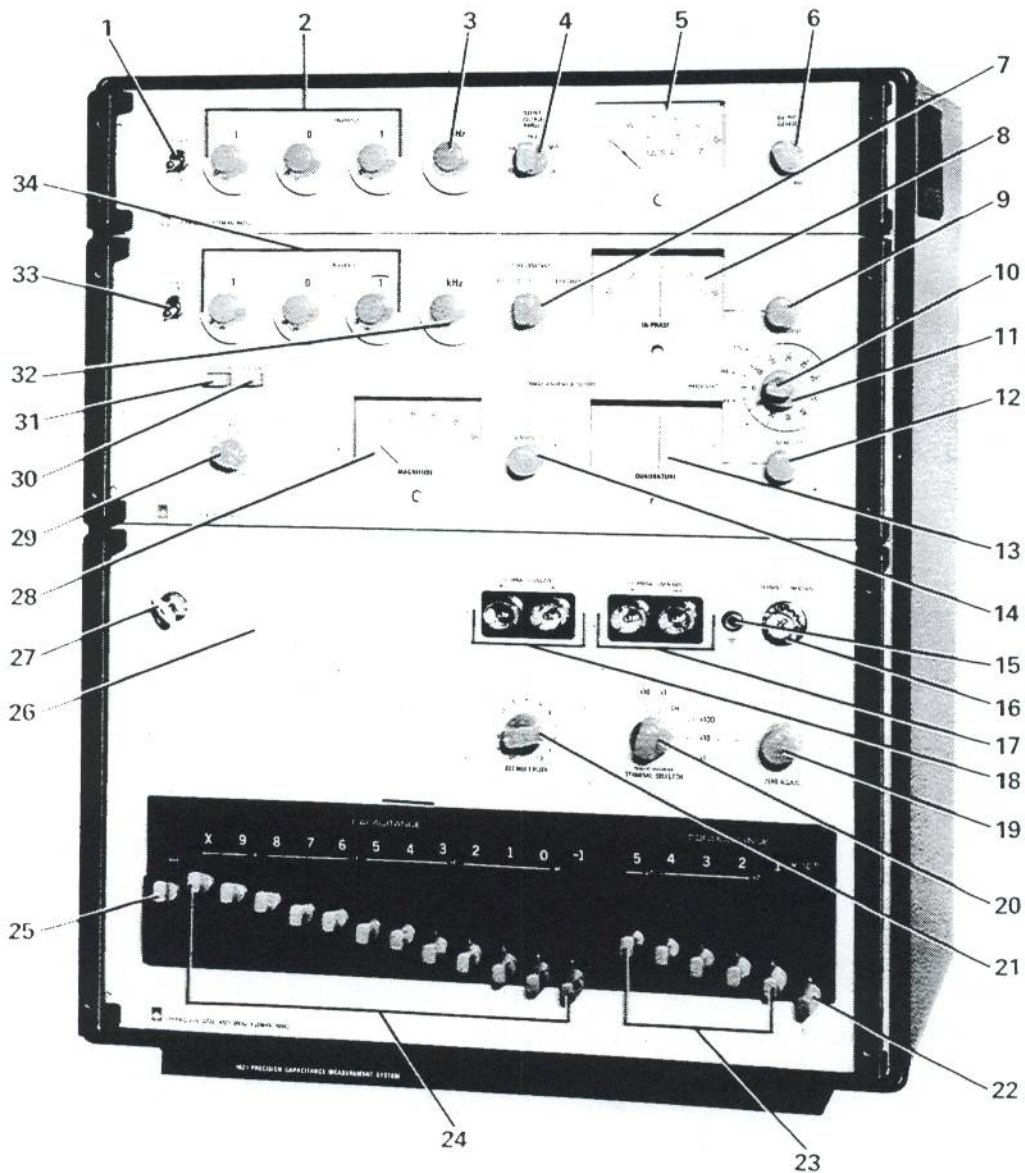

**Figure 1-2. Front-panel controls, indicators, and connectors of the 1621 Precision Capacitance-Measurement System.**

Table 1-1

## FRONT-PANEL CONTROLS, INDICATORS, AND CONNECTORS

Fig. 1-2 Item	Name	Description	Function
<i>Oscillator</i>			
1	POWER switch	Toggle switch, down position: OFF.	Turns oscillator on and off.
2	FREQUENCY selector	Set of 2 rotary switches with decimal steps, 0 ... 9, and 1 stepless pot with similar calibration and detent at 0. Illuminated decimal points.	Selects and indicates frequency, a 3-digit number. Decimal-point illumination serves as pilot light.
3	FREQUENCY range switch	Rotary switch with 4 positions: Hz, Hz, kHz, kHz.	Selects a frequency range, indicates units, and controls illuminated decimal point in item 2.
4	OUTPUT-VOL-TAGE RANGE switch	Rotary switch with 5 positions: 1.5, 5.0, 15.0, 50.0, 150.	Selects output-voltage range and indicates full-scale meter range (item 5). Simultaneously switches the output impedance from 0.25 $\Omega$ to 2.5 k $\Omega$ in decade steps.
5	Voltmeter	Ac meter with 0-50 and 0-15 scales; has mechanical zero-adjustment screw.	Indicates output terminal voltage, in ranges selected by item 4.
6	OUTPUT ADJUST	Stepless rotary pot with limits labeled 0 and MAX.	Controls output level in the range selected by item 4.
<i>Detector, Right Side</i>			
7	TIME CONSTANT	Rotary switch with 5 positions: 0.1, 0.3, 1, 3, 10 SECONDS.	Controls the smoothing (integration) of detected signals and hence, effectively, the meter damping.
8	IN-PHASE meter	Zero-center meter graduated 50-0-50; has mechanical zero-adjustment screw.	Indication of one component of bridge error signal, such as the C component.
9	FINE ADJUST (IN-PHASE)	Stepless rotary pot.	Adjusts phase of item-8 reference so the quadrature component is rejected (a fine adjustment).
10	PHASE SHIFT (smaller knob)	Rotary switch with 4 positions: 0°, 90°, 180°, 270°	Selects phase shift in coarse steps, supplemented by items 9, 11, 12.
11	PHASE SHIFT (larger knob)	Stepless rotary control, calibrated -50° to +50°.	Shifts phase-detector references; set so that nearby meters (items 8, 13) respond independently to C and G error.
12	FINE ADJUST (QUADRATURE)	Stepless rotary pot.	Adjusts phase of item -13 reference so the in-phase component is rejected (a fine adjustment).
13	QUADRATURE	Zero-center meter graduated 50-0-50; has mechanical zero-adjustment screw.	Indication of one component of bridge error signal, such as the G component.
14	SENSITIVITY control	Stepless rotary pot.	Fine gain control; use it to keep IN-PHASE and QUADRATURE meters reading on scale (does not affect MAGNITUDE meter).

Table 1-1 (Cont)

## FRONT-PANEL CONTROLS, INDICATORS, AND CONNECTORS

Fig. 1-2 Item	Name	Description	Function
<i>Bridge</i>			
15	Ground	Socket for banana plug.	Direct connection to master ground (electrical midpoint of ratio transformer) and chassis.
16	2-TERMINAL UNKNOWN port	G900 precision coaxial connector.	Connection for 2-terminal "unknown" capacitor. Note: Neither terminal may be connected directly to gnd (item 15); outer = high; inner = low (Fig. 1-1).
17	3-TERMINAL UNKNOWN port	Pair of G874 coaxial connectors, LOW and HIGH.	Connection for 3-terminal "unknown" capacitor. Note: outer shields are tied to master gnd (item 15).
18	EXTERNAL STANDARD port	Pair of G874 coaxial connectors, identified as HIGH and LOW.	Connection for 3-terminal external standard capacitor for special measurements, comparisons, or range extension.
19	ZERO ADJUST	Stepless 10-turn pot.	Capacitance offset adjustment. Range: a few aF in CAL or 3-TERM positions of item 20; 3, 3, and 50 pF (respectively) in 2-TERM X1, X10, and X100 positions.
20	TERMINAL SELECTOR (READOUT MULTIPLIER)	Rotary switch with 6 positions: 3 TERMINAL (X10, X1); CAL; 2 TERMINAL (X100, X10, X1).	Selects which UNKNOWN port (items 16, 17) connects to the bridge, or neither (CAL position); grounds the terminals of each port not so connected. Selects the READOUT MULTIPLIER — apply it to both C and G.
21	EXT MULTIPLIER switch	Rotary switch with 13 positions: OFF, -0.1, 0, 0.1 ... 1.0	Gives any external standard (at item 18) one of 12 weights (including zero) or disconnects that port from the bridge and grounds both terminals.
22	CONDUCTANCE multiplier lever	Lever switch with 7 positions identified as: X1 ... X10 <sup>-6</sup> .	Gives the conductance standards an additional set of multipliers.
23	CONDUCTANCE standards levers	Set of 5 lever switches, each 12-position with <i>readout</i> indicator: -1, 0, 1 ... 9, X. 1st digit, $\mu$ S next 3 digits, nS;	Determines effective value of internal conductance standards, along with items 20, 22. Note: at G balance, unknown = (readout X CONDUCTANCE multiplier + ext std G X EXT MULT) X READOUT MULTIPLIER.
24	CAPACITANCE standards levers	Set of 12 lever switches, each 12-position with <i>readout</i> indicator: -1, 0, 1 ... 9, X. 1st 2 digits, nF; then in blocks of 3: pF, fF, aF.	Determines effective value of internal capacitance standards, along with item 20. Note: at C balance, unknown = (readout + ext std C X EXT MULT) X READOUT MULTIPLIER.
25	C MAX switch	Lever switch with 4 positions. Up, no effect; down, shutters over 1st 3 capacitance digits, cumulatively in 3 steps.	Allows insertion or removal of first 1, 2, or 3 (largest) standard capacitors from bridge. Each is removed when a shutter covers its indicator. Note: removal of large standards not used serves to reduce capacitive loading across detector (for best sensitivity); setting item 24 to zero does not.
26	C-standards trimmers	Set of 12 screwdriver adjustments hidden behind a small panel; labels: 100 nF ... 1 aF.	To trim or adjust internal C standards if necessary. Labels indicate nominal (X1) weight of corresponding standard when its switch is up ( <i>readout</i> = X).

**Table 1-1 (Cont)**  
**FRONT-PANEL CONTROLS, INDICATORS, AND CONNECTORS**

Fig. 1-2 Item	Name	Description	Function
27	C-standards trimmers lock	Lock with keys.	Secures the small panel over item 26 to preserve its adjustments.
<i>Detector, Left Side</i>			
28	MAGNITUDE meter	Meter, calibrated 0 to 100; has mechanical zero-adjustment screw.	Indication of bridge-error-signal level.
29	GAIN, dB	Step attenuator; 12 positions, 20 ... 130 dB.	Coarse gain control; use it to keep MAGNITUDE meter reading on scale.
30	COMPRESSION	Push-button switch (push to engage, push again to release).	Out: linear response, full gain. In: compressed response, 20-dB-larger signal can be handled with meters on scale.
31	LINE REJECTION	Push-button switch (push to engage, push again to release).	Out: normal. In: 40-dB attenuation of line-frequency component in bridge error signal. (Circuit can be adapted for 60 or 50 Hz.)
32	Frequency-range switch	Rotary switch with 5 positions: FLAT, Hz, Hz, kHz, kHz.	Selects broad-band characteristic or frequency range of tuned response, indicating the units and controlling the decimal point in item 34.
33	POWER switch	Toggle switch, up: ON; down: OFF.	Turns detector on and off.
34	FREQUENCY selector	Set of 3 rotary switches with decimal steps, 0 ... 10. Illuminated decimal points.	Selects and indicates frequency to which detector is tuned (unless item 32 says FLAT). Decimal point illumination serves as pilot light.

**Table 1-2**  
**REAR-PANEL CONTROLS AND CONNECTORS**

Fig. 1-3 Item	Name	Description	Function
<i>Oscillator</i>			
1R	QUADRATURE REFERENCE OUTPUT	BNC jack *	Provides a reference output, 90° leading the "in-phase" reference, at 1.3 V open circuit (connect to item 21R).
2R	IN-PHASE REFERENCE OUTPUT	BNC jack *	Provides the other reference output, at the same level. Approx in phase with item 4R. (connect to item 20R).

Table 1-2 (cont)

REAR PANEL CONTROLS AND CONNECTORS

Fig. 1-3 Item	Name	Description	Function
3R	EXT SYNC	BNC jack*	Use for synchronization, if desired. As an input, lock range is $\pm 2\%/V$ rms, up to 10 V. As an output: 0.3 V behind 27 k $\Omega$ .
4R	POWER OUTPUT	BNC jack*	Main output, up to 1.6 W max, may be 125 V open circuit or 5A short circuit (connect to item 13R).
5R	8/10 AMP fuse	Fuse in extractor-post holder	Protection against damage from short circuit.

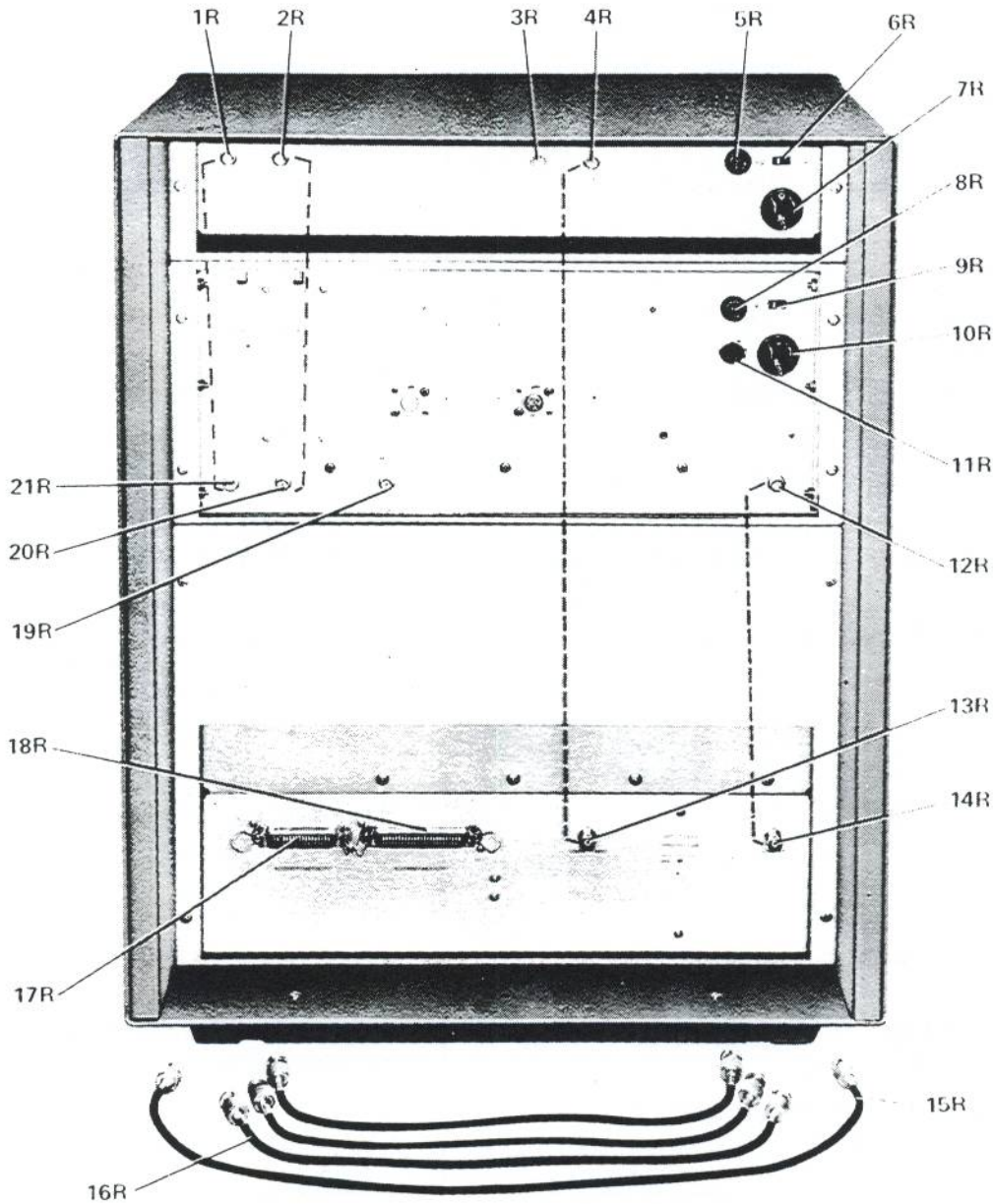

Figure 1-3. Rear-panel controls, connectors, and cables. Dashed lines indicate cable connections.

**Table 1-2 (Cont)**  
**REAR-PANEL CONTROLS AND CONNECTORS**

Fig. 1-3 Item	Name	Description	Function
6R	Line-voltage switch	Slide switch (labeled 50-60 Hz); 2 positions: 100-125 V, 200-250 V.	Accommodates power supply to either range of line voltages.
7R	Power plug	3-pin power plug. †	Connects from power line and earth ground.
<i>Detector, Left Side</i>			
8R	1/2 AMP fuse	Fuse in extractor-post holder	Protection against damage from short circuit.
9R	Line-voltage switch	Slide switch (labeled 50-60 Hz) 2 positions: 100-125 V; 200-250 V.	Accommodates power supply to either range of line voltages.
10R	Power plug	3-pin power plug. †	Connects from power line and earth ground.
11R	DC-METER OUTPUTS	5-pin socket.	Outputs for remote metering; all 3 meter circuits included.
12R	INPUT SIGNAL	BNC jack.*	Main input to be detected (connect from item 14R).
<i>Bridge and Cables</i>			
13R	GENERATOR INPUT	BNC jack.*	Input port for audio-frequency power to bridge circuitry. Connect from item 4R.
14R	DETECTOR OUTPUT	BNC jack.*	Output port for bridge error signal (unbalance). Connect to item 12R.
15R	0776-2020	BNC patch cord	Interconnect items 4R, 13R.Δ
16R	0776-2040 8161-5200	BNC patch cord BNC patch cord (red band)	Connect items 1R to 21R, 2R to 20R Δ. Connect items 12R to 14R Δ.
17R	BCD CONDUCTANCE OUTPUT	36-pin socket	Indicates in BCD code to external instruments the CONDUCTANCE-readout and CONDUCTANCE-multiplier values (items 22, 23) and the position of the TERMINAL SELECTOR (READOUT MULTIPLIER) switch (item 20).Δ
18R	BCD CAPACITANCE OUTPUT	50-pin socket	Indicates similarly the CAPACITANCE readout, i.e., the positions of the levers of items 24 and 25.Δ
<i>Detector, Right Side</i>			
19R	AMPLIFIER OUTPUT	BNC jack*	Output for remote instrumentation; ac voltage.
20R	IN-PHASE REF INPUT	BNC jack*	Input reference for phase-sensitive detectors; required level > 1 <sup>-</sup> V rms.
21R	QUADRATURE REFERENCE INPUT	BNC jack*	Input like 18R except leading that by 90°.

\*BNC jack accepts Amphenol "BNC" plug or military connector no. UG-88/U.

ΔRefer to para. 2.8.

† Refer to note, pg. 1-12.

**Table 1-3**

**ACCESSORIES SUPPLIED WITH THE 1621 SYSTEM**

Name	Description or Function	GR Catalog No. (Type)
Power cord	3-wire AWG number 18 type SVT cable, rated at 7A, 230 V. The connectors, designed for 125-V operation, conform to the Standard for Grounding Type Attachment Plug Caps and Receptacles, ANSI C73.11-1963. Length: 7 ft. 2 required (1 each for oscillator and detector).	4220-0220
Patch cords	Shielded cable with BNC plugs; see para. 2.8;	
	length 15 in. (2 req'd)	0776-2040
	length 24 in. (1 req'd)	0776-2020
	length 15 in., double shielded, red banded (1 req'd)	8161-5200
Plug	To fit DC METER OUTPUTS socket; pins: 5 (Amphenol 126-217).	4220-5401
Cap	Plastic dust cover for G900 connector	0900-7190

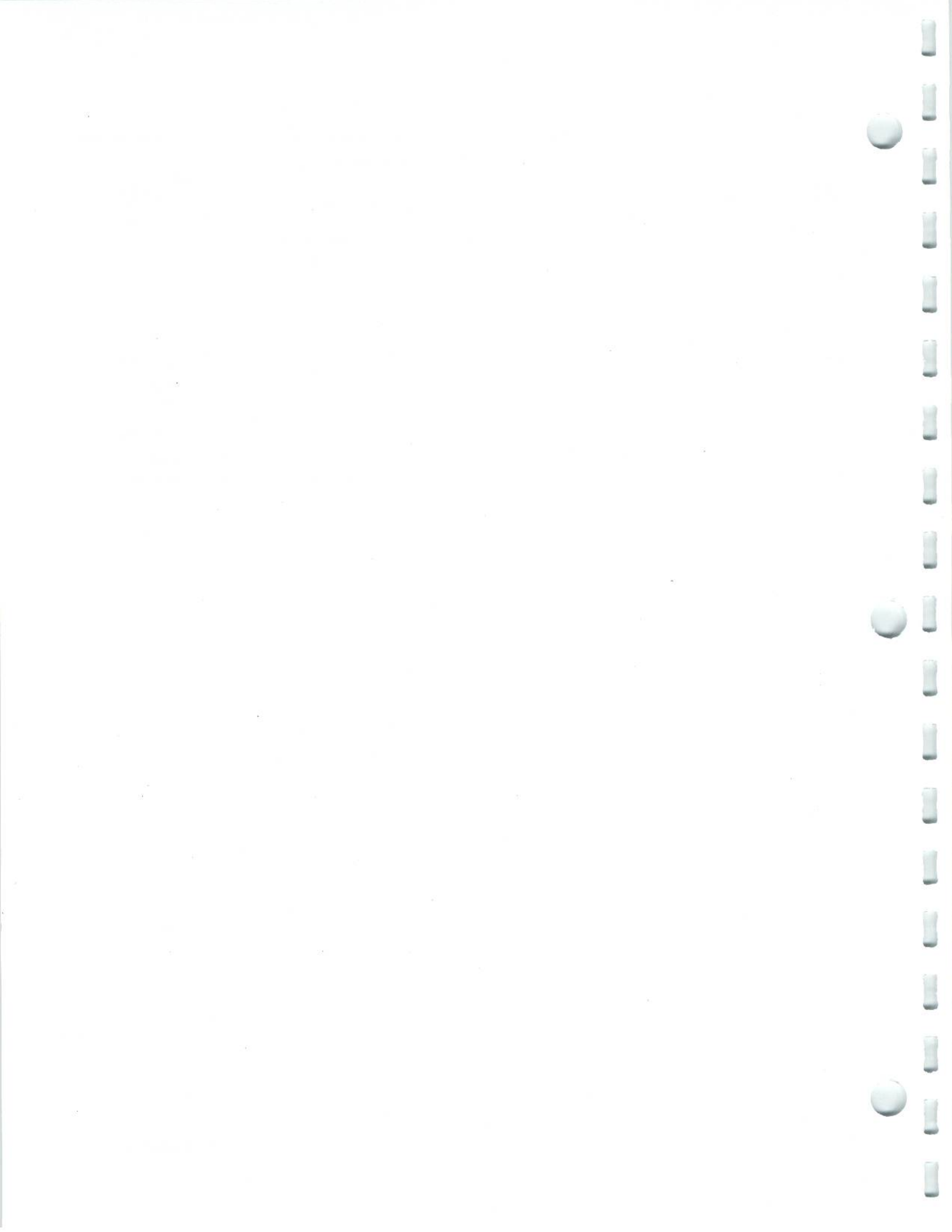



# Installation – Section 2

2.1 GENERAL . . . . .	2-2
2.2 DIMENSIONS . . . . .	2-2
2.3 ENVIRONMENT . . . . .	2-2
2.4 BENCH MODELS . . . . .	2-2
2.5 RACK MODELS . . . . .	2-2
2.6 POWER-LINE CONNECTION . . . . .	2-4
2.7 LINE-VOLTAGE REGULATION . . . . .	2-4
2.8 SYSTEM CONNECTIONS . . . . .	2-4

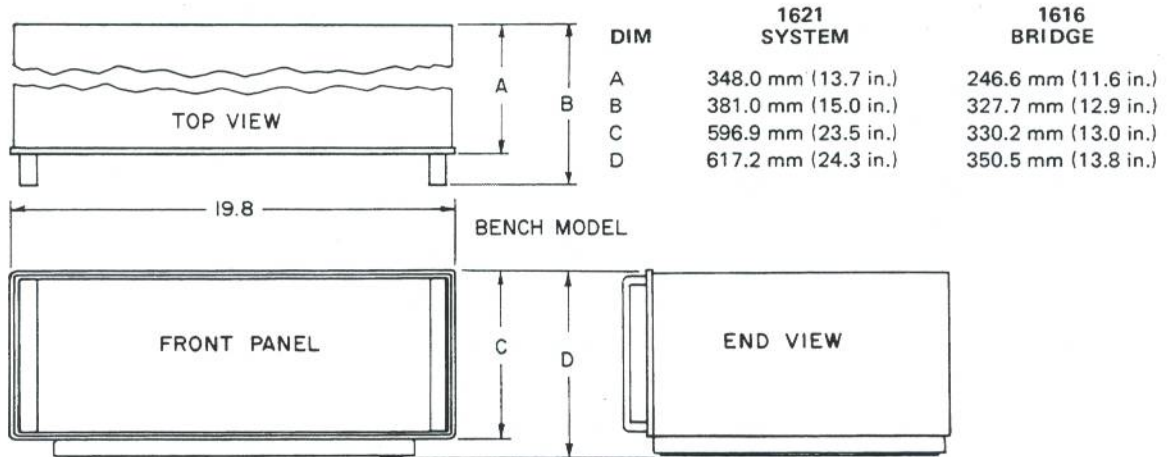

Figure 2-1. Dimensions of the bench models.

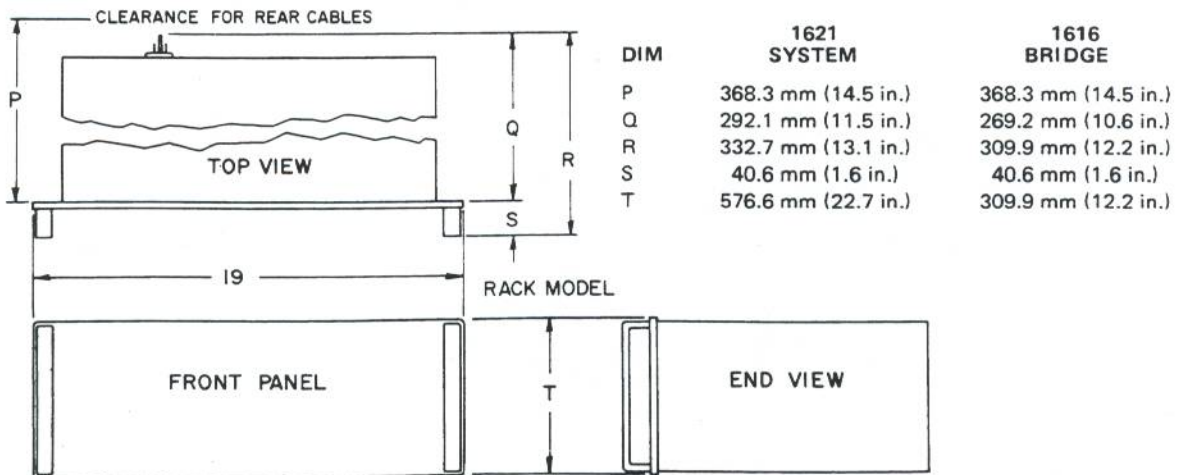

Figure 2-2. Dimensions of the rack models.

## 2.1 GENERAL.

The 1621 Precision Capacitance Measurement System, or the 1616 Bridge alone, is available for either bench use or for installation in an EIA Standard RS-310 19-in. relay rack with universal hole spacing. Appropriate cabinet and hardware sets are available for conversion of a bench model for rack installation or vice versa.

Locate the instrument for convenience of operation and in a suitable environment. Avoid blocking the flow of air through the vents. Some open bench area, to the right or in front of the bridge, should be provided.

### NOTE

If you assemble a 1621 System from separate instruments, either install them in the 4177-2621 cabinet or consult GenRad about the need for a magnetic shield between bridge and detector. If you convert a 1621 from bench to rack, transfer the magnetic shield.

## 2.2 DIMENSIONS.

The dimensions of bench and relay-rack models of the system and of the bridge are given in Figures 2-1 and 2-2.

## 2.3 ENVIRONMENT.

The system is designed to operate in standards laboratories, in which the environment is typically very well controlled. All specifications are valid over a temperature range of 22-24°C. Storage range is -20 to +70°C.

## 2.4 BENCH MODELS.

Figure 2-3.

### 2.4.1 Cabinet Removal.

To remove the bench-model cabinet, first stand the system (or instrument) in the normal, horizontal position, free of all cables, and proceed as follows:

a. Remove the 4 dress-panel screws (A) accessible through holes in the handles of each instrument.

b. Withdraw each instrument forward, out of the cabinet.

### 2.4.2 Conversion for Rack Mounting.

To convert a bench instrument for rack mounting, exchange the cabinet and install appropriate hardware, as follows:

a. Obtain the appropriate Rack-Mounting Cabinets, as described in Table 2-1, from GenRad.

b. Obtain, optionally, a Bracket Set (Table 2-1) for each cabinet. Brackets are especially recommended for heavy instruments, which need support from the rear rail of the rack.

Table 2-1

Quantity	Description	Part No.
1	Rack-mounting cabinet (for oscillator).	4174-3240
1	Rack-mounting cabinet (for detector).	4174-3624
1	Rack-mounting cabinet (for bridge).	4174-3627
3	Sets of rear-support brackets and screws (1 for each instrument).	4174-2007

c. Remove the cabinet, as in paragraph 2.4.1.  
 d. Remove the rear cover from the bench cabinet, with screws (B, Figure 2-3), for later installation on the rack cabinet.  
 e. Proceed with the rack installation, skip to paragraph 2.5.2, step b.

## 2.5 RACK MODELS.

### 2.5.1 General.

Each rack model comes completely assembled in a suitable metal cabinet, which is designed to stay semi-permanently in a rack. Each instrument can be drawn forward on extending tracks for access with support, or (with a lift)

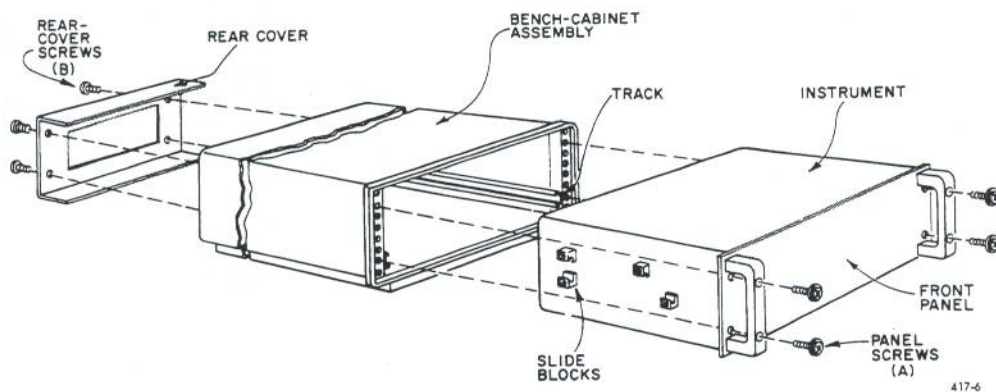
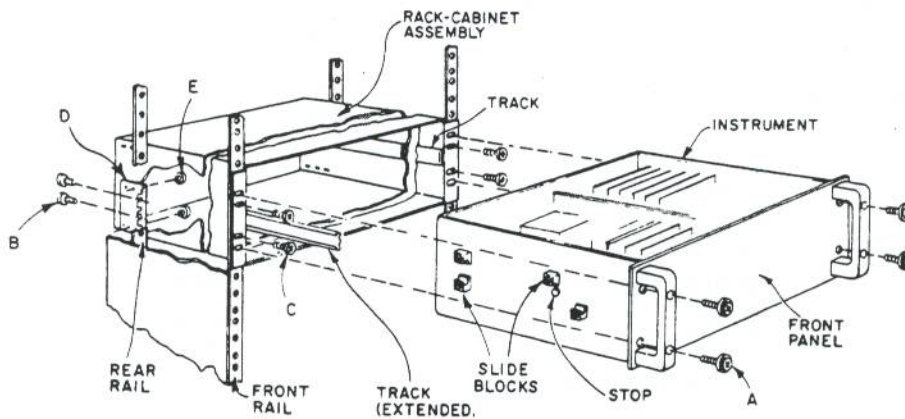

Figure 2-3. Bench-cabinet installation.



417-5

Figure 2-4. Rack-cabinet installation.

withdrawn completely. The cabinets listed in Table 2-1 are all included with a rack-model 1621 system, together with screws. Table 2-2 lists the screw sizes for reference.

Table 2-2

KEY TO SCREW SIZES

Ref Figs. 2-3; 2-4	Description	No. — thds/in.	Length, inch
A	Dress-panel screws with washers	10-32	.56
B	Thread-cutting screws	10-32	.50
C	Thread-cutting screws	10-32	.50
E	Thread-forming screws	8-32	.19

2.5.2 Installation.

Figure 2-4.

Directions follow for mounting the cabinet in a rack and installing the instrument on its tracks:

a. Remove 4 dress-panel screws (A) and slide the instrument out of the cabinet until the tracks are fully extended. Continue pulling the instrument forward until motion along the tracks is stopped. At this juncture, tilt the front of the instrument up slightly and continue withdrawal, past the stops, until it is free.

b. Insert the rack cabinet wherever desired in the rack — be sure it's level — and fasten it with 4 screws (C) to the front rails.

c. If the rack contains a rear support rail, use brackets (D) to support the cabinet with the rear rails; open-slotted screw holes allow positioning.

d. Use the set of slots in the sides of the cabinet that allow alignment of the open-slotted holes in the brackets with threaded holes in the rail. The long flange should extend to the rear.

e. Insert screws (E) from inside the cabinet, through the slotted holes and drive them into the holes in the long flange of the bracket. Each side takes 2.

NOTE

Start the screws in the appropriate holes off the rack, to make the threading easier.

f. Pass screws (B) through brackets and screw 2 into each rear rail. (Details may be varied to suit particular situations.)

g. To install the instrument, first set its rear edge in the cabinet front opening. Slide the instrument back, making sure that the rear and the upper front slide blocks engage the tracks. (Stops prevent further insertion.)

h. Pull the instrument forward *with* the tracks, keeping a hand on each side (fingers underneath). Slide the instrument back about 1/2 in. along both tracks, past the stops, by pressing down on the tracks (with thumbs) while tilting the front of the instrument up slightly.

i. Push the instrument back into the rack, checking for smooth operation of the tracks and slide blocks.

NOTE

The instrument is now readily accessible for behind-the-panel adjustments. It slides in and out freely on extending tracks.

2.5.3 Conversion to Bench Use.

To convert a rack-mounting instrument for bench use, exchange the cabinet, as follows:

a. Obtain a Bench Cabinet, part no. 4177-2621 for the 1621 system, or 4172-4106 for the 1616 bridge alone, from GenRad.

b. Remove the instrument from the rack cabinet, after removing the panel screws (A, Figure 2-4). (When free motion along the tracks is stopped, tilt the front of the instrument up slightly to clear the stops.)

c. Slide the instrument into the bench cabinet.

d. Fasten instrument to cabinet using dress-panel screws (A, Figure 2-3).

e. Transfer the rear cover, with screws (B), from rack cabinet to bench cabinet.

## 2.6 POWER-LINE CONNECTION.

Power requirement for the 1621 system is 51 W at 100-to-125 or 200-to-250 V, 50-to-60 Hz. Make connection as follows:

a. Set the line-voltage switches on the rear panels of oscillator and detector (Figure 1-3) to correspond with the available power-line voltage. Use a small screwdriver to slide the switch.

b. Connect the external power line to each power plug using the power cords supplied or equivalent, 3-conductor cords (para. 1-4).

The fuses should have the current ratings shown on the rear panels (Figure 1-3) regardless of which line-voltage range is chosen in step a.

## 2.7 LINE-VOLTAGE REGULATION.

The accuracy of measurements accomplished with precision electronic test equipment operated from ac line sources can often be seriously degraded by fluctuations in primary input power. Line-voltage variations of  $\pm 15\%$  are commonly encountered, even in laboratory environments. Although most modern electronic instruments incorporate some degree of regulation, possible power-source problems should be considered for every instrumentation setup. The use of line-voltage regulators between power lines and the test equipment is recommended as the only sure way to rule out the effects on measurement data of variations in line voltage.

## 2.8 SYSTEM CONNECTIONS.

Figure 1-3.

### 2.8.1 Oscillator, Bridge, and Detector.

Make the 4 essential connections among the instruments, using the 4 BNC patch cords supplied with the 1621 system (refer to Table 1-3) as follows:

a. Test power to the bridge: 1316 POWER OUTPUT to 1616 GENERATOR INPUT.

b. Unbalance signal to the detector: 1616 DETECTOR OUTPUT to 1238 INPUT SIGNAL. (Red-banded cable).

c. Reference signals to the detector: 1316 REFERENCE OUTPUTS to 1238 REFERENCE INPUTS (one cable for IN PHASE, one for QUADRATURE).

### 2.8.2 BCD-Capacitance-Output Connector. Figures 1-3, 2-5.

Make connections from the BCD CAPACITANCE OUTPUT socket at the rear of the bridge, if you want to record or process the C-measurement data with a printer, card-

punch coupler, or comparator. Use a 50-pin plug, Amphe-nol P/N 57-30500 (or equivalent) and cable such as Alpha No. 1181/50, which has AWG No. 22 stranded wires.\* For pin identification, refer to Figure 2-5.

Notice that the output data is provided by switch closures only. The switches in the bridge are rated for up to 0.5 A at 110 V (ac) with resistance loads. If, however, you want for example a logical "1" (the *on* state of each data bit) to be represented by +5 V with respect to the system ground (pin 30) then use an external +5-V power supply and connect it from ground to VREF (pin 25). Logical "0" is an open circuit.

The capacitance readout is available in binary-coded decimal form, the code being "1-2-4-8" as detailed in Table 2-3. The body of the table contains only binary numbers, composed of bits 0 and 1. Notice the extension of the usual BCD table, to include X (ten) and negative 1.

*As an example, suppose the bridge readout is 396 pF. Figure 2-5 shows us that pins 20, 19, 43, 17, 16 and 40 are "1", while pins 45, 44, 18, 42, 41, and 15 are "0".* This kind of data is commonly accepted by printers.

However, suppose the bridge readout is  $4(-1) 6$  pF — the same capacitance! Figure 2-5 and Table 2-3 tell us that pins 44, 43, 18, 17, 16 and 40 are "1" while pins 20, 19, 45, 42, 41 and 15 are "0".

A sufficiently sophisticated system will make a computation and print 396 pF (for example). A simple system utilizes a 12-character printer (including -1 and X as well as the usual 0 . . . 9) and will print out just what the bridge readout shows. If the system must use a printer that does not recognize -1 and X a logic circuit may be fabricated, to detect the occurrence of either -1 or X anywhere in the readout, and trigger an alarm such as a buzzer or a change in color of the printout. (Table 2-3 shows that when both 2-weight and 8-weight binary signals of any one decimal digit are "1", there is such an occurrence. In our example, the pins involved are numbered 18 and 43.)

Either provide the system complexity needed to handle data containing -1 and X without ambiguity, or make sure that the operator removes them from his final balance adjustment. Operating instructions in this manual are written for the latter case.

#### NOTE

The capacitance data must be scaled up by 1, 10, or 100 (the READOUT MULTIPLIER) code for which is given below.

\* Alpha Wire Corp., Elizabeth, N.J.

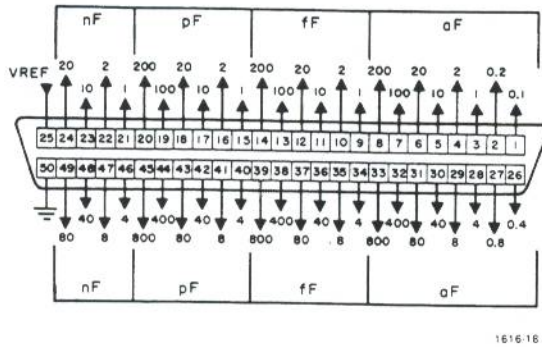

Figure 2-5. Terminal identification at BCD CAPACITANCE OUTPUT connector (A-J13, rear panel of bridge). Arrow toward connector = input; away = output. These weights apply when the TERMINAL SELECTOR switch is set to READOUT MULTIPLIER = X1 (either of 2 settings). This is a rear view, exterior of socket.

The BCD output is zero for any internal standard that has been removed from the bridge by the C MAX switch, regardless of the position of the lever switch normally controlling that standard.

Table 2-3

BINARY-CODED DECIMALS (BCD)				
Signal Weight (Binary)				Digit (Decimal)
8	4	2	1	
1	0	1	1	-1
0	0	0	0	0
0	0	0	1	1
0	0	1	0	2
0	0	1	1	3
0	1	0	0	4
0	1	0	1	5
0	1	1	0	6
0	1	1	1	7
1	0	0	0	8
1	0	0	1	9
1	0	1	0	X

### 2.8.3 BCD-Conductance-Output Connector. Figures 1-3, 2-6.

Make connection, similarly, from the BCD CONDUCTANCE OUTPUT socket, using a 36-pin plug, Amphenol P/N 57-30360 (or equivalent). For pin identification refer to Figure 2-6. In addition to the basic conductance-readout data, here is multiplier data.

The *conductance* multiplier is one of 7 values,  $1 \dots 10^{-6}$ . Its exponent (magnitude only, expressed in BCD code) appears at pins 13, 14, and 30. For example: these 3 pins at "0" state means zero exponent, i.e. the G multiplier is 1.

The READOUT MULTIPLIER is one of 3 values, X1, X10, X100. However, the BCD data has 6 possible values, corresponding to the 6 positions of the TERMINAL SELECTOR switch, as shown in Table 2-4.

For example: a binary 101 (decimal 5) means the READOUT MULTIPLIER is X10 and (incidentally) the measurement is being made via the 2-TERMINAL port.

If your printer has decimal points, drive them from the READOUT MULTIPLIER as follows (for printout in pF): pins 33, 34, 35 drive the points following columns 5, 6, 7, respectively. Printing of a 2nd point indicates 2-terminal X1 or X10; all 3 points indicate CALIBRATION.

Table 2-4

READOUT-MULTIPLIER CODE				
4	Weight 2	1	Decimal (Equiv.)	TERMINAL-SELECTOR Switch Position
0	0	1	1	X10 3-terminal
0	1	0	2	X1 3-terminal
1	1	1	7	CAL
1	0	0	4	X100 2-terminal
1	0	1	5	X10 2-terminal
1	1	0	6	X1 2-terminal

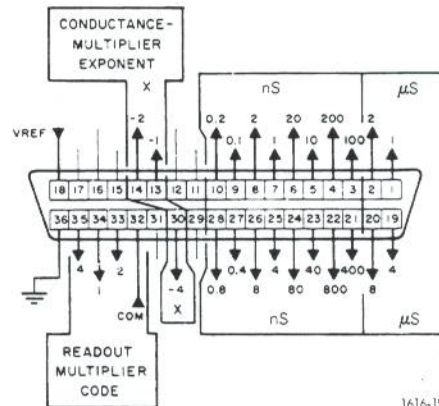

Figure 2-6. Terminal identification at BCD CONDUCTANCE OUTPUT connector (A-J12, rear panel of bridge). Arrow toward connector = input; away = output. The indicated conductance weights apply directly when the effective multiplier is 1, for example: CONDUCTANCE multiplier =  $10^{-2}$  and READOUT MULTIPLIER = X100. This is a rear view, exterior of socket.

### 2.8.4 Analog Outputs. Figures 1-3, 2-7.

**AMPLIFIER OUTPUT.** Use a BNC patch cord to connect this signal to remote monitoring or recording equipment if desired. This ac signal is proportional to the MAGNITUDE meter deflection, and is 4 V rms at full scale.

**DC METER OUTPUTS.** Use the 5-pin plug supplied (see Table 1-3) and cable suited to your system, if you wish to have remote indication of the 1238 front-panel meter

deflections. A suitable cable is Alpha No. 1175, which contains AWG No. 22 wires.

Pins are designated as shown by Figure 2-7. *Only pin H of these circuits may be grounded.* A is +, B is - for the MAGNITUDE meter circuit (6 V corresponds to full-scale deflection.) D is +, H is - for the IN PHASE meter circuit; E is +, H is - for the QUADRATURE meter circuit. For each of these 2 circuits, the level is 1 V for full-scale deflection of the corresponding front-panel meter, when the SENSITIVITY control is ccw (minimum). However,

because that control affects the front-panel meters, *not* the DC METER OUTPUT voltage, the voltage is relatively lower when that control is cw.

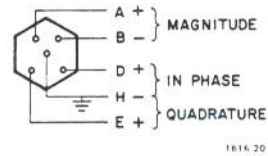

**Figure 2-7. DC METER OUTPUTS socket on 1238 Detector, exterior (rear) view.**

# Operation – Section 3

3.1 PRELIMINARY CHECKS . . . . .	3-1
3.2 FUNCTIONAL SELF-CHECK . . . . .	3-1
3.3 PHASE ADJUSTMENT . . . . .	3-2
3.4 CONNECTION OF UNKNOWN CAPACITOR . . . . .	3-3
3.5 BALANCE AND READOUT . . . . .	3-4
3.6 PARAMETERS OF THE UNKNOWN CAPACITOR . . . . .	3-7
3.7 FREQUENCY . . . . .	3-8
3.8 VOLTAGE LEVEL . . . . .	3-10
3.9 ACCURACY . . . . .	3-10
3.10 PRECISION . . . . .	3-14
3.11 EXTERNAL STANDARDS . . . . .	3-15
3.12 PRECISE COMPARISONS . . . . .	3-17
3.13 NON-COAXIAL 2-TERMINAL CAPACITORS . . . . .	3-17
3.14 DC BIAS . . . . .	3-20
3.15 REVERSED CONFIGURATION . . . . .	3-22



## WARNING

**Dangerous voltages may be present at the terminals of this instrument.  
Refer to specific warnings contained in this section.**

## NOTE

The following instructions apply literally to the 1621 system. If your 1616 bridge is connected to an oscillator and/or detector other than the GR 1316 and 1238, interpret the corresponding parts of this section appropriately.



## CAUTION

**Do not connect a power cord until each line-voltage switch has been set properly.**

matches your power-line frequency (or reset it), refer to the 1238 Instruction Manual.

c. Check that the 4 BNC patch cords are in place at the rear, connecting oscillator, detector, and bridge as described in paragraph 2.8.

d. Check that 4 meters read zero (2 of them at mid-scale). If necessary, adjust each with a small screwdriver, at the recessed screw just below the meter.

e. Set the OUTPUT VOLTAGE RANGE to 15 V. (Higher voltages should be used only when they are needed, usually to facilitate high precision in measurements.)



## WARNING

**Beware of hazardous voltages:  $\leq 350$  V at 3-TERM UNKNOWN HI or EXT STD HI;  $\leq 35$  V at 2-TERM UNKNOWN HI (outer shell), while oscillator is set to a high level.**

### 3.1 PRELIMINARY CHECKS.

Refer to paragraph 1.3 for figures illustrating the controls, indicators, and connectors and for tabulation of their functional descriptions. The recommended initial operating procedure follows:

a. Check that the line-voltage switches on the rear panels of oscillator and detector are positioned according to the available power-line voltage (either 100-125 V or 200-250 V). To slide these switches, use the tip of a small screwdriver

b. The LINE REJECTION filter in the 1238 Detector has been set for 50 or 60 Hz by GR (it can be purchased either way) or by a user. If you need to verify that it

f. Connect the power plugs (rear panel) to a suitable power line, using the power cords supplied. Flip the POWER switch up (front panel) on each, oscillator and detector. Verify that a decimal point is illuminated in each FREQUENCY selector.

### 3.2 FUNCTIONAL SELF-CHECK.

Adjust oscillator and detector to the same frequency and make a balance to check for system operation, as follows:

a. Set the front-panel controls as listed (from upper left to lower right, Figure 1-2):

- FREQUENCY – 1.01 kHz (Oscillator)
- OUTPUT VOLTAGE RANGE – 15.0
- OUTPUT ADJUST – MAX
- FREQUENCY – 1.01 kHz (Detector)
- TIME CONSTANT – 0.1 s
- LINE REJECTION – push button out
- COMPRESSION – push button out
- GAIN – 30 dB
- SENSITIVITY – ccw (minimum)
- PHASE SHIFT – 180°
- FINE ADJUST – midrange (both controls)
- EXT MULTIPLIER – OFF (Bridge)
- TERMINAL SELECTOR – CAL
- ZERO ADJUST – ccw
- C MAX – down (Asterisks below represent 3 closed shutters.)
- CAPACITANCE – \*\* nF \*05 pF 000 fF 000.0 aF
- CONDUCTANCE – 0 μS 000.0 nS X 10<sup>6</sup>

b. Reset the GAIN if necessary to make the MAGNITUDE meter read near midscale (20 to 80).

c. Tune the detector to match the oscillator, as indicated by a peak reading of the MAGNITUDE meter, to the nearest step. Fine tune with the oscillator 3rd dial.

d. Reset the CAPACITANCE to \*\* nF \*\*00 pF 000 fF 000.0 aF. Verify that MAGNITUDE drops to zero.

e. Reset the GAIN to 100 dB. Observe that a noticeable unbalance occurs when the 1-fF lever is moved to 1 or -1.

### 3.3 PHASE ADJUSTMENT.

In order to enjoy the convenience of the phase-sensitive indicators, adjust the phase shifters as described below. The adjustment is then useful as long as the frequency is unchanged, the detector FREQUENCY remains tuned for maximum response, and the CONDUCTANCE multiplier is unchanged. Readjustment of phase shift may be made while the bridge is being balanced; refer to paragraph 3.5.

#### NOTE

The goal is to minimize the response of one phase-sensitive meter to changes in C, the other to changes in G. The following procedure, though not ideal for every measurement condition, is adequate in general.

a. Reestablish the null reading on the MAGNITUDE meter, as in para 3.2. However, set the CONDUCTANCE multiplier so its exponent is -5, -4, -3, -2, for a frequency of 0.1, 1, 10, or 100 kHz, respectively. Then switch GAIN to 60 dB and unbalance the bridge by raising CAPACITANCE lever switches only, making the MAGNITUDE meter read about 20. (For the first attempt, use the 10 fF lever.)

b. With the SENSITIVITY control, set the signal level in the phase-sensitive detectors so that either IN PHASE or

QUADRATURE meter reads 25 or more (in either direction) and both read on-scale.

c. With the PHASE SHIFT controls, bring the QUADRATURE meter approximately to zero. If the range of the larger knob is not sufficient, turn the smaller knob to an adjacent position.

d. Now the IN PHASE meter should read upscale, to the right (because C readout is greater than C unknown). Reverse the direction of the meter deflection, if necessary, by turning the smaller PHASE SHIFT knob 2 clicks.

e. See that both FINE ADJUST knobs are set to a mid position (dot L). Increase the C unbalance until the MAGNITUDE meter reads 80-99. Set SENSITIVITY to max, cw. Set the PHASE SHIFT for zero on the QUADRATURE meter. If zero cannot be obtained with the PHASE SHIFT, use the QUADRATURE FINE ADJUST.\*

f. Reestablish the null reading and refine it, if necessary, using the C and G levers. The MAGNITUDE reading should not exceed 2, or ¼ division.

g. Unbalance the bridge by raising CONDUCTANCE lever switches, achieving about the same magnitude of unbalance as before – 80-99. (Try using the 1-μS lever.) Now the QUADRATURE meter should read upscale, to the right (G readout is greater than G unknown). Trim the IN PHASE FINE ADJUST *only* to make the adjacent meter read zero, or a minimum. (Do not expect zero at all possible G unbalances at high freq.)

h. If, in step g, the meter reads down scale, interchange the IN PHASE and QUADRATURE connections at the REFERENCE INPUTS behind the 1238 Detector. Then repeat steps a through g, above.

Table 3-1  
SENSES OF PHASE-SENSITIVE METERS

REFERENCE connections	Meter	PHASE-SHIFT controls set to			
		0°	90°	180°	270°
Normal	IN PHASE	C←	G←	C→	G→
Normal	QUADRATURE	G←	C→	G→	C←
Crossed	IN PHASE	G←	C←	G→	C→
Crossed	QUADRATURE	C←	G→	C→	G←

We have assumed that it is preferable for the IN PHASE meter to respond upscale (to the right) for  $C_s > C_x$ ; and the QUADRATURE meter, similarly, for  $G_s > G_x$ . However, if you prefer to associate "IN PHASE" with "conductance", interchange the REFERENCE connections at the rear panel (cross the patch cords). If you prefer the opposite sense of response, set PHASE SHIFT near 0° instead of 180°. Table 3-1 shows the 8 possible combinations.

\*Phase adjustment is now adequate for most measurements. Steps f and g are refinements.

### 3-2 OPERATION



### 3.4 CONNECTION OF UNKNOWN CAPACITOR

#### 3.4.1 Three-terminal Capacitors.

Figure 3-1.

As the simplified diagram shows, the 3-terminal measurement evaluates the direct capacitance  $C_x$  (and conductance) between HIGH and LOW bridge terminals. Shielded cables or patch cords (G874-422A or 874-R22LA) may be used to connect these terminals to a capacitance to ground ( $C_{ls}$ ,  $C_{hs}$ , including cable capacitances) are excluded from the measurement, but if large enough they may affect accuracy.

**Enclosure.** Check that the capacitor to be measured is enclosed in a shield, for connection to bridge ground. Not only is the shield necessary for precision measurements, but it must be mechanically fixed (permanently or repeatably) for  $C_x$  to be defined. Physically, as the shield gets larger and farther from the plates of  $C_x$ , the value of  $C_x$  becomes larger and less dependent on spacing of the shield. However, that dependency never vanishes.

Use the 3-terminal component mount G874-X, or (if that is too small) a metal box, if an enclosure must be supplied.

**Connectors.** Check that the "unknown" capacitor has two coaxial connectors for convenient connection to the bridge. If the capacitor is relatively small and light weight and is equipped with G874 connectors spaced 1.25 in. apart (center-to-center), patch cords are not necessary. The capacitor can then be plugged directly into the bridge. However, shielded patch cords are convenient, their use allows the capacitor being measured to sit on a bench surface or at a remote location. The parameters of such cables are negligible in a 3-terminal measurement, except for noise introduced into the detector when they are moved.

Provide connectors if necessary, such as those listed in Table 1-5. Connect the capacitor to the 3-TERMINAL UNKNOWN ports.

**Reversal.** The measured direct capacitance is not changed in most three-terminal measurements when the connections to the capacitor are reversed, i.e., bridge HIGH to capacitor L instead of bridge HIGH to capacitor H.

**Shielding.** Keep both HIGH and LOW connections shielded as a general rule. At least one *must* be shielded or the capacitance between connecting terminals and wires becomes part of the measurement.

The HIGH connection may be made without shielding, if you prefer. This terminal, being at the high-voltage but low-impedance output of the transformer, is not sensitive to pickup from external sources and seldom needs to be shielded. There is voltage from the HIGH terminal to ground. Much capacitance or conductance connected from this terminal to ground reduces the transformer output voltage and introduces possible errors into the measured direct capacitance and conductance. In general, keep such shunt C below 200 pF (see para. 3.9).

Keep the LOW connection shielded. This terminal, being at the low-voltage but high-impedance input to the detector, is very sensitive to noise and signal pickup from ex-

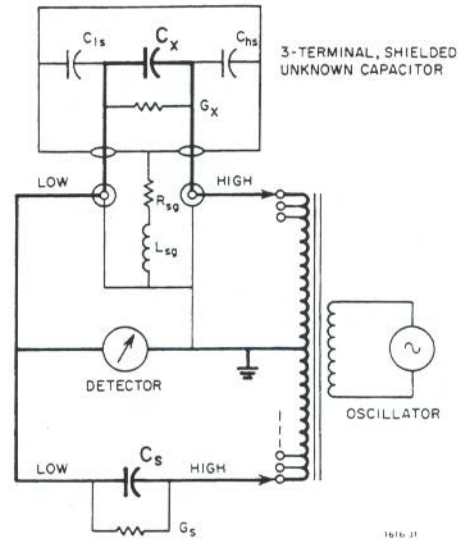

Figure 3-1. Simplified bridge diagram — 3-terminal connection of unknown capacitor.

ternal sources and must be completely shielded for low-capacitance or any precision measurements. There is no voltage from LOW to ground when the bridge is balanced. Much capacitance or conductance from the LOW terminal to ground shunts the detector, and by reducing sensitivity limits the precision of your measurements. In general, keep such shunt C below 200 pF.

Capacitance of the recommended patch cord, G874-R22A (or 874-R22LA) is 90 pF.

#### 3.4.2 Two-terminal Coaxial Capacitors.

Figure 3-2.

As the diagram shows, a 2-terminal measurement evaluates the capacitance  $C_x$  (and conductance) between the inner conductor and the shell of a coaxial structure. The inner conductor connects to LOW bridge terminal (which must be shielded for precision measurements), the shell to HIGH. Although the shell serves as a shield, do *not* connect it to ground. Capacitance to ground  $C_{hg}$  is excluded from the measurement.



#### WARNING

Beware of possibly hazardous voltage on shell of "unknown" capacitor whenever generator is set to a high level.

If necessary, use of a coaxial adaptor (or special test fixture) between the single G900 connector on the bridge panel and the capacitor being tested. The capacitance of any such adaptor is included in the measurement. However, the ZERO ADJUST control can be used to compensate the bridge — up to 3 pF — making the CAPACITANCE READOUT direct-reading for any unknown capacitor connected to the adaptor, as described below.

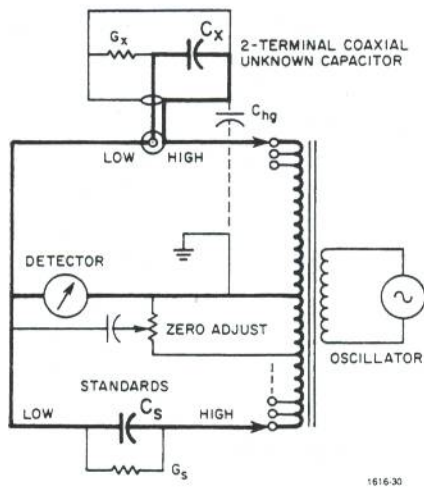

**Figure 3-2. Simplified bridge diagram – 2-terminal connection of unknown capacitor.**

**NOTE**

Non-coaxial 2-terminal capacitors can also be measured; refer to para. 3.13.

**Enclosure.** Check that the capacitor to be measured is so constructed that the shell shields the inner terminal, and that both are isolated from ground. Use the 2-terminal component mount G874-ML if an enclosure must be used.

**Connector.** Check that the capacitor has G900 or G890 connector for convenient connection to the bridge. If not, provide the latter type, or whatever fits your special test fixture (see below).

**Zero Adjustment.** Compensate the bridge for capacitance of its 2-terminal connector and – if one is used – the attached short coaxial line, as follows:

a. Check that the front-panel controls are set as of the completion of functional checks and phase adjustment, paragraphs 3.2 and 3.3. (Frequency is optional; see para. 3.7.)

b. Set the TERMINAL SELECTOR to 2 TERMINAL X1, X10, or X100 for measurements up to 1 nF, 10 nF, or 10  $\mu$ F, respectively.

c. Set CAPACITANCE lever switches to the value of the fringing capacitance of the connector that will receive the unknown capacitor. In the simple case that the READOUT MULTIPLIER is X1, no adaptor is needed, and accuracy of  $\pm 8$  fF is sufficient, select CAPACITANCE and CONDUCTANCE readouts as follows:

\*\* nF \*00 pF 115 fF 000.0 aF and 0  $\mu$ S 000.0 nS  $\times 10^{-6}$ .

If the READOUT MULTIPLIER was set to X10 or X100, use proportionally smaller settings (11 fF 500 aF, or 1 fF 150 aF, respectively). For greater accuracy, refer to para. 3.9.5.

d. Adjust the ZERO ADJUST control for minimum reading on the IN PHASE meter. Turn the GAIN control to

90 dB, or as far as is appropriate to get a good indication for this adjustment.

The adjustment is now valid for a particular terminal capacitance and READOUT MULTIPLIER. If you change either of these (and leave the TERMINAL SELECTOR on one of the three 2-TERMINAL positions) repeat the zero adjustment.

e. Connect the capacitor to the 2-TERMINAL UNKNOWN port.

**Special Test Fixtures.** The details of special fixtures are beyond the scope of this manual. However, these comments apply:

1. The ZERO ADJUST range is sufficient to compensate up to about 3 pF with READOUT MULTIPLIER set at X1 or X10, 56 pF at X100. Therefore, bridge readings will generally need correction (by subtraction) unless you provide an external capacitor for test-fixture compensation. Refer to para. 3.11.

2. Highly precise measurements are possible; refer to "direct substitution", para. 3.12.

3. Mount the test fixture directly on the 2-TERMINAL UNKNOWN port or use rigid coaxial lines, elbows, etc. (Flexible cables change capacitance with position. If you use them, your precision is only about  $\pm 0.1$  pF.)

4. Support the fixture, if it's on a long, rigid line, to avoid damage to the panel-mounted connector. Lock each connector so it will not shift position.

5. Consider also the possibility of connecting your fixture to the 3-TERMINAL UNKNOWN port; thereby taking advantage of the fact that various cable and ground capacitances are excluded from the measurement.

**NOTE**

Refer also to NON-COAXIAL 2-TERMINAL CAPACITORS, para. 3.13.

**3.5 BALANCE AND READOUT.**

**Figure 3-3.**

This is the actual measurement process. Preceding paragraphs explain how to tune oscillator and detector, make phase adjustments, and connect the capacitor to be measured. Balance the bridge, as follows, and you have the measurement in both visual and digital forms. The standards for measurement are contained in the bridge.

**3.5.1 Readout Multiplier.**

Set the TERMINAL SELECTOR to the appropriate X1 position (2 or 3 terminal) unless the capacitor being measured is larger than 1 nF (1000 pF). Then set the selector to the highest READOUT MULTIPLIER (X10 for 3-terminal, X100 for 2-terminal measurements).

The purpose is to utilize one of the three "pF" lever switches for the most significant digit, if possible, thus maximizing the accuracy of your measurement.

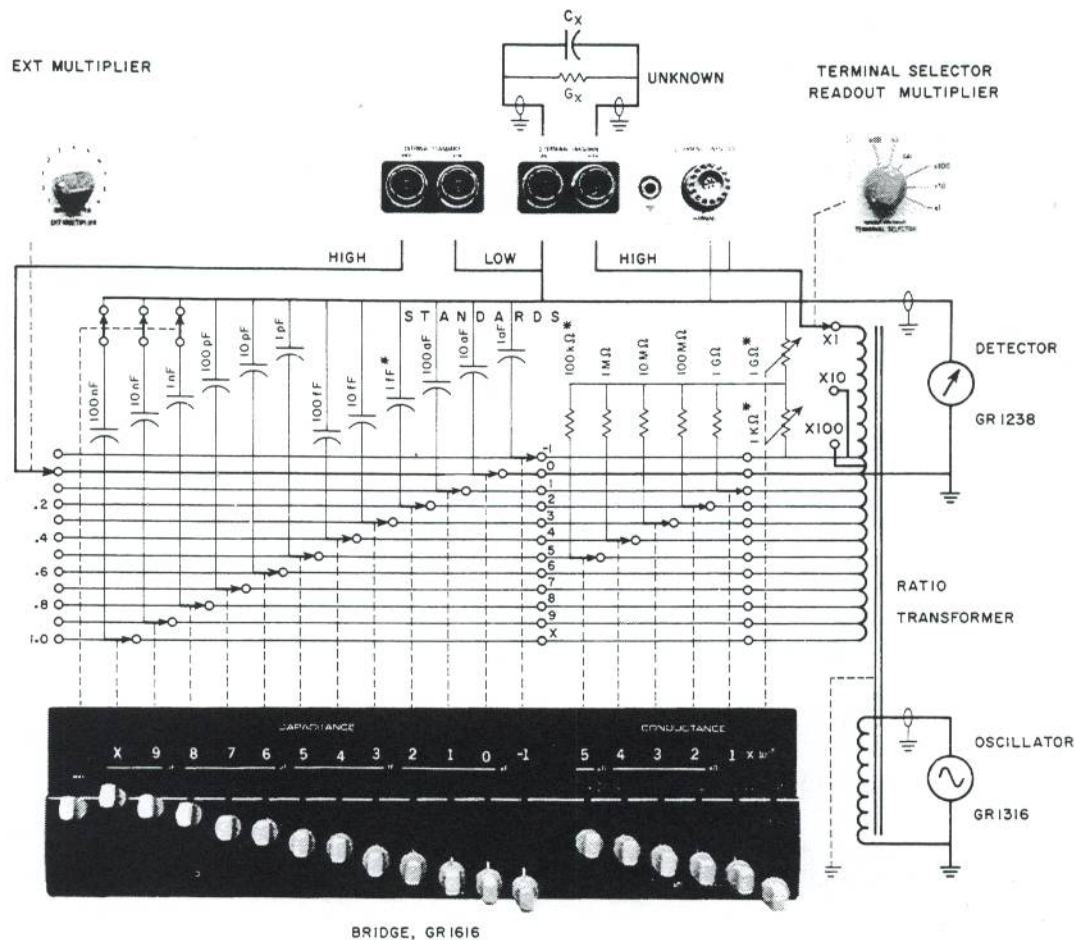

Figure 3-3. The 1621 Capacitance-Measurement System — simplified diagram. \*Note: Effective values are shown for all G standards and for C standards smaller than 1 pF.

### 3.5.2 Initial Settings of Lever Switches.

If the capacitor value is known, even approximately, set that value into the CAPACITANCE readout, and set the doubtful digits at the right to 5's.

For example, if the capacitor is about 12 pF, set the bridge to read 12 pF 555 fF 555.5 aF.

**C MAX.** Move the C MAX lever down, covering as many as 3 of the unused digits to the left of the desired readout. Covering as many as possible of the zeroes at the left of the final readout helps to maximize the precision of your measurement, by removing stray capacitance which otherwise loads the ratio transformers slightly.

**CONDUCTANCE.** For a typical measurement, set the CONDUCTANCE levers initially to the zero readout: 0  $\mu$ S 000.0 nS  $\times 10^{-6}$ . However, if conductance is known approximately, set the levers to that approximation.

**Unknown, A Black Box.** If the capacitance or conductance settings cannot be set initially to the right order of magnitude, the MAGNITUDE meter will read off-scale. Temporarily, use the following aids to obtain a preliminary balance:

- Push the COMPRESSION button in.

- Turn OUTPUT VOLTAGE RANGE and OUTPUT ADJUST *ccw* as may be required to bring the MAGNITUDE meter on-scale.

- Explore large ranges of C and G lever-switch settings, leaving most of the levers at zero so that the ones being moved are always most-significant digits.

- Watch the phase-sensitive meters (even though they may be pinned and not properly phase related). A reversal of sense (pointer crossing midscale) is an indication of passing near a rough balance.

### 3.5.3 Balance Procedures.

Figures 1-2, 3-3.

**GAIN.** Set the GAIN control initially so the MAGNITUDE meter reads in the upper half scale. Later, as balance is improved, turn the control *ccw* to maintain useful readings on the other 2 meters.

**SENSITIVITY.** Set the SENSITIVITY control initially at midrange. Later, as balance is improved, adjust for a large on-scale reading on one or both of the IN PHASE and QUADRATURE meters.

## NOTE

Keep the MAGNITUDE meter on scale, otherwise the phase sensitive detectors may be overloaded. However, the IN-PHASE and QUADRATURE meters may be pinned without loss of phase sense indication.

**TIME CONSTANT.** Set the TIME CONSTANT initially to 0.1 s, for immediate response to your balancing operation.

Later, as balance is improved and the GAIN control has to be set quite high, turn to larger time constants. A noisy reading (meter pointer jumping) can be expected at high gain if the time constant is too low. So increase it to calm jittery IN-PHASE and QUADRATURE meters, allow time enough for each reading, and you can achieve a highly precise balance.

**Lever Switches.** Decide which levers to adjust first by looking at the PHASE-SENSITIVE DETECTOR meters. If the IN PHASE meter reads farther from zero, adjust CAPACITANCE first; if QUADRATURE, adjust CONDUCTANCE.

**CAPACITANCE balance.** Refine the balance as follows, left-to-right:

a. Start with the most significant digit that is in doubt. Preferably, every CAPACITANCE digit to the right of it should be set to 5.

b. Push the lever down if the IN PHASE meter reads up scale; pull up if it reads down scale. Continue until the meter pointer crosses zero.

c. Leave that lever in the position closest to balance, i.e., making the IN PHASE meter point closest to zero, on either side.

d. Adjust the next lever to the right, similarly, if there is sufficient meter deflection to be a guide. (If the suggestion in step a is used, you will probably not have to readjust the lever you set in step c.)

e. Increase the GAIN as much as necessary to provide that deflection, but not enough to deflect the QUADRATURE meter off scale.

f. Continue refining the capacitive balance until the QUADRATURE indication becomes a limitation, then refine the CONDUCTANCE balance.

**CONDUCTANCE balance.** If an approximately correct conductance setting has been initiated, refine the conductance balance from left to right, similarly to the capacitance balance. Minimize the reading of the QUADRATURE meter.

However, if the CONDUCTANCE levers have been set to zero, as described above, proceed as follows:

a. Raise the CONDUCTANCE levers from 0 to 5, starting at the left of the multiplier and continuing left until either the QUADRATURE meter pointer crosses zero (if so, skip to step c) or all these levers have been raised.

If the meter points to the right, drop the most-significant lever to  $-1$ , so the readout is  $-1 \mu\text{S } 555.5 \text{ nS } \times 10^6$ , and skip to step c.

If the meter points to the left or zero, drop the most-significant lever to  $+1$ , so the readout is  $1 \mu\text{S } 555.5 \text{ nS } \times 10^6$ .

b. Raise the conductance multiplier lever until the meter crosses zero and stop at the setting nearest balance. If this lever is set to X1 or  $\times 10^1$ , PHASE SHIFT will have to be reset, as described below.

c. Refine the conductance balance as outlined above (for capacitance) starting with the left-most ( $\mu\text{S}$ ) lever and proceeding to the right.

### 3.5.4 Final Balance.

Alternate between CONDUCTANCE and CAPACITANCE balances, as described above, improving whichever is worse until the other becomes a limitation.

**Conclusion.** Stop when the desired precision has been achieved. The bridge is probably capable of greater resolution than you need.

**Voltage.** If there seems to be a gain or noise limitation, even though GAIN is 130 dB and TIME CONSTANT is 10 s, raise the oscillator OUTPUT VOLTAGE. However, do not exceed the level of 350 V rms. If the frequency is less than 2200 Hz, *do not exceed 0.16 f volts*, where f is frequency in Hz.



### WARNING

While generator is set to a high level, beware of hazardous voltages:  $\leq 350 \text{ V}$  across 3-TERM UNKNOWN or EXT STD;  $\leq 35 \text{ V}$  across 2-TERM UNKNOWN (outer shell high).

**Phase Shift / Fine Adjust.** While making a precise measurement of a low-loss capacitor, check as follows:

a. As the 4th significant digit of C is being selected, verify that the QUADRATURE meter responds negligibly (compared to the IN-PHASE meter) for C-lever changes.

b. Correct the phase if necessary with the QUADRATURE FINE ADJUST control.

c. When balancing conductance, make the corresponding check (and adjustment) of the other phase.

### NOTE

A slight change in tuning of either oscillator or detector will affect phase, even though the change has negligible effect on magnitude of response.

**Phase Shift / Reset.** If the capacitor is lossy, the phase-shift settings of paragraph 3.3 are unsuitable. Reset as follows:

a. Make an initial balance, watching the MAGNITUDE

meter, until the 4th significant digit of C or G has been chosen (whichever predominates).

b. Temporarily turn SENSITIVITY and GAIN controls down enough to bring both phase-sensitive meters within 1/2 division of zero (scale value of 2.5). Set both FINE ADJUST controls to mid range (pointer up).

c. Unbalance the bridge by raising C levers (or G if it predominates) enough to make large deflections on these meters.

d. If C predominates, adjust PHASE SHIFT for zero QUADRATURE and upscale IN-PHASE meter readings. Raise the GAIN and SENSITIVITY settings as is appropriate; refine the phase with the QUADRATURE FINE ADJUST control (as described under *Phase Shift / Fine Adjust*).

If G predominates, adjust similarly, for zero IN-PHASE and upscale QUADRATURE meter readings.

e. Return to the initial-balance condition, then unbalance G (or C). The meter that read upscale in step d should not deflect. Trim the nearest FINE ADJUST control for this condition.

#### NOTE

Be sure the EXT MULTIPLIER switch is OFF (not simply zero) whenever the EXTERNAL STANDARD terminals are unused.

Even though those terminals are open, their stray capacitance may introduce error into the measurement of capacitors below 1 fF and the unshielded LOW terminal may pick up enough "noise" to have a detrimental effect on precision.

#### NOTE

Keep the MAGNITUDE meter reading on scale.

If the MAGNITUDE meter is pinned, distortion in the detector may cause a spurious phase shift. However, the IN PHASE and QUADRATURE meters may point off scale without loss of sense information.

### 3.5.5 Readout Correction.

Figure 3-3.

If there is a -1 or X in the CAPACITANCE or CONDUCTANCE numbers displayed above the lever switches, it is generally recommended to correct the readout as follows:

a. Proceed from left to right unless X is adjacent to -1, in either order. (Correct the right-hand digit first in any such pair.)

b. Change each -1 to 9 and decrease the preceding digit by one.

c. Change each X to 0 and increase the preceding digit by one.

d. Verify that the final balance is still valid.

e. The readout is now correct for manual recording. Also, if your measurement system makes use of the BCD

output data (rear panel) that data is now in standard form. Refer to para. 2.8.

#### NOTE

There may be occasions when it is desirable or necessary to leave X in the readout.

If, for example, the bridge balances at \*\* nF X23 pF 456 fF 785.5 aF (the last 2 or 3 digits may be insignificant) you have this choice: For greatest accuracy and a record as to which internal standard is significant, leave the X in the readout. Take the responsibility for making sure the recorded data is unambiguous (particularly if a printer is being driven from the BCD CAPACITANCE OUTPUT). For a simpler readout, move the C MAX lever and correct the readout to \*1 nF 023 pF 456 fF 785.5 aF. But then the bridge is almost certainly unbalanced; if you now refine the balance you are almost certainly reducing accuracy by depending on a larger, less accurate internal standard.

### 3.5.6 Units of Measurement.

The units of each, C<sub>x</sub> and G<sub>x</sub>, appear on the front panel; but be sure to apply the multipliers. For example, (Figure 1-2) if the readout is X9.8 nF and the READOUT MULTIPLIER indicates X10, C<sub>x</sub> is 1098 nF or 1.098 μF.

The conductance readout has 2 multipliers. For example, if the readout is 5.43 μS X 10<sup>-6</sup> and the READOUT MULTIPLIER indicates X100, G<sub>x</sub> is 5.43 X 10<sup>-4</sup> μS or 5.43 X 10<sup>-10</sup> S.

#### NOTE

The symbol "S" represents the Siemens unit, the unit of conductance (or admittance). Siemens is equivalent to mho (the reciprocal of ohm), represented by the symbol Ω.

## 3.6 PARAMETERS OF THE UNKNOWN CAPACITOR.

### 3.6.1 Series Equivalent Parameters.

Figure 3-4.

This bridge always measures directly the parallel equivalent parameters C<sub>x</sub> and G<sub>x</sub>, even in case the loss component of the unknown capacitor is in fact entirely in series (as resistance of the connecting leads). Whether a series R-C, a parallel R-C, or a more elaborate equivalent circuit best describes the capacitor you are measuring cannot be decided on the basis of one measurement. At the very least, measure at several frequencies; there is further discussion in Section 4.

Here in this paragraph is a group of formulas and diagrams relating the parallel equivalent parameters to the series equivalent parameters. Notice that D, Q, and ω are equally valid members in either set of parameters.

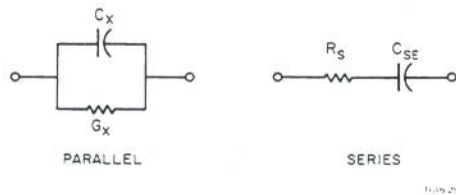

Figure 3-4. Equivalent circuits of the unknown capacitor.

$$C_{SE} = C_x \left[ 1 + \left( \frac{G_x}{\omega C_x} \right)^2 \right] = C_x (1 + D^2)$$

$$R_s = \frac{G_x}{G_x^2 + \omega^2 C_x^2} = \frac{1}{G_x (Q^2 + 1)}$$

$$D = \frac{G_x}{\omega C_x} = \omega R_s C_{SE} = \frac{1}{Q}$$

$$C_x = \frac{C_{SE}}{1 + (\omega R_s C_{SE})^2} = \frac{C_{SE}}{1 + D^2}$$

$$G_x = \frac{(\omega R_s C_{SE})^2}{R_s [1 + (\omega R_s C_{SE})^2]} = \frac{1}{R_s (Q^2 + 1)}$$

where C = capacitance in farads  
 G = conductance in Siemens  
 R = resistance in ohms  
 $\omega = 2\pi f$   
 f = frequency in hertz.

### 3.6.2 Dissipation Factor.

Dissipation factor or loss tangent D (the reciprocal of storage factor Q) is defined above. Refer also to para. 4.2. D is presented in convenient, graphical form in Figure 3-5, which is used as follows:

a. Find  $C_x$  on the appropriate scale, if the measurement frequency is one of those given. Otherwise, notice that the horizontal scale is really the product  $fC_x$ . The higher your frequency, the farther right your capacitance scale shifts. (For example, at 3 kHz, imagine the 1-kHz scale shifted to the right nearly half a decade; if your  $C_x = 8$  pF, locate 24 pF on the 1-kHz scale.) Imagine a vertical line through that point, representing  $fC_x$ .

b. Find  $G_x$  on the slanted scale. Imagine a slanted line to represent  $G_x$ .

c. Find D on the vertical scale, directly left of the intersection of your  $fC_x$  and  $G_x$  lines.

d. For greater precision, use the expanded partial chart (but determine order of magnitude from step c). For still higher precision, use the formula:  $D = G_x / 2\pi f C_x$ .

If the range of bridge measurement is extended by the

use of an external standard, extrapolate the corresponding scale. (For example, an external standard of conductance may be advantageous for measuring large, lossy capacitances at high frequency. Add more slanted lines in the upper right portion of chart to represent such an extension.)

The shaded square in the main chart and that of the expanded partial chart represent the same range of data. A visual impression of the magnitude of this expansion helps you use the partial chart.

## 3.7 FREQUENCY.

### 3.7.1 Setting the Frequency.

To make measurements at any frequency in the range 10 Hz-100 kHz, set the oscillator FREQUENCY selector dials and range switch so that they read as desired. Their indicators together make a convenient, in-line readout.

The 3rd-digit selector is a continuous control (although the readout indicates only 10 positions). From the detent, at the zero position, this control can be rotated cw, through the indicated decade range, or ccw for a small negative extension of that range. Observe the limitations on high voltage at high frequency as described below.

In brief, use the following procedure to set the frequency of measurements by the 1621 Precision Capacitance-Measurement System:

- Set the oscillator FREQUENCY controls.
- Set the detector FREQUENCY controls to match. Without balancing the bridge, peak the response of the MAGNITUDE meter by fine tuning of the oscillator.
- Make the phase adjustment as in paragraph 3.3.

#### NOTE

Unless your measurement must be made at exactly 1.00 kHz (for example) set the oscillator a little above such a round number. Doing so will simplify the tuning of detector and oscillator to the same frequency.

### 3.7.2 Monitoring Frequency.

- Connect a counter to the EXT SYNC connector (rear).
- Select PERIOD measurement (1  $\mu$ s TIME BASE) and 10 PERIODS AVERAGED on the counter. For a frequency near 10 Hz, most or all of the counter readout is now utilized. The most significant digits will spill over to the left as you proceed; remember them as they disappear.
- Increase the PERIODS AVERAGED, turning the control cw as far as is necessary to obtain the desired resolution of measurement.
- Calculate frequency, the reciprocal of the period just measured.

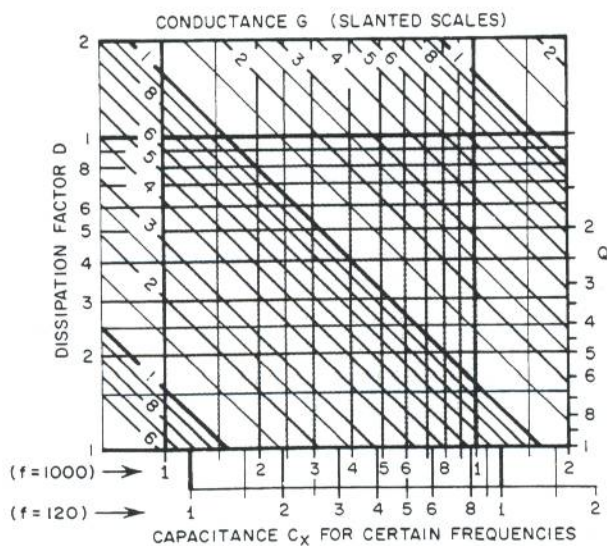
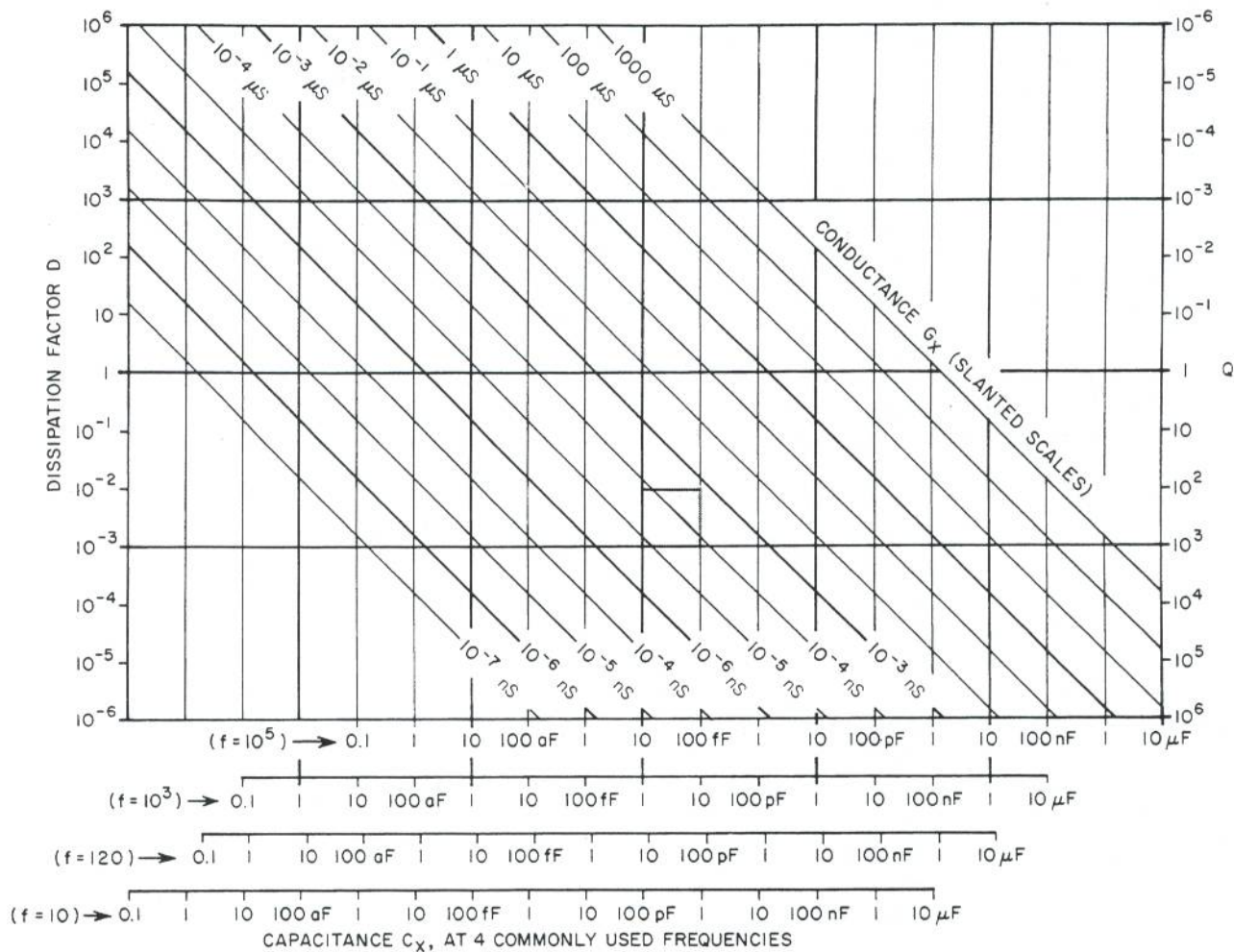

1616-28

Figure 3-5. Dissipation factor vs directly measured parameters. Above: entire range of bridge with internal standards. Left: expanded partial chart, used for greater resolution. For any arbitrary frequency, enter  $C_x$  scale at correct product  $fC_x$ . (Example: if  $f=60$ ,  $C_x=6$  pF, use the scale for " $f=120$ " but read " $C_x=3$  pF").

### 3.7.3 Locking to a Frequency Reference.

If the reference frequency is known within  $\pm 1\%$ , and the reference source can drive the 27-k $\Omega$  EXT SYNC circuit with 1-10 V rms, proceed as follows:

- a. Connect the reference source to the EXT SYNC jack.
- b. Tune the capacitance-measuring system to the reference frequency, setting the phase shift as described before. However, if the reference frequency is not known to  $\pm 1\%$ , or its signal level is  $< 1$  V rms, follow this procedure:
  - a. Using a tee, connect both the frequency reference and a scope to the EXT SYNC jack.
  - b. Vary the 1316 Oscillator frequency over a range of 30% or so, observing the scope. It should be possible to see both varying-frequency and fixed-frequency components in the waveform. (Synchronize the scope, preferably, to the reference.)
  - c. Tune the oscillator through lock, a condition in which the waveform "stands still". Determine the range over which lock can be maintained, and set the FREQUENCY dials to the center of that range.
  - d. Tune the detector and set the phase shift.

### 3.8 VOLTAGE LEVEL.

**Selection.** The source voltage is selected by the 2 controls, OUTPUT VOLTAGE RANGE and OUTPUT ADJUST, on the 1316 Oscillator. Read the front-panel meter, full scale being the number indicated by the OUTPUT VOLTAGE RANGE switch. Another source can be used instead; but always select a level within the limits described below, and never more than **350 V rms, max.\***

**Frequency Dependence.** Select a source voltage  $\leq 0.16$  f volts rms, to avoid saturation in the bridge ratio transformer. For example, at frequencies of 0.1, 1.0, 10, & 100 kHz, maximum levels are 16, 160, 350, & 350 V rms.

#### NOTE

Voltages at the unknown capacitor, greater than this limit, can be obtained by using the reversed configuration of para. 3.15.

**Large capacitors.** You can resolve large C at high frequency using relatively low voltage. Appropriately, levels available in the 1621 system are then limited by oscillator loading. Normal operation is below these limits: level  $< 4 \times 10^{-3} / fC$  volts rms for OUTPUT VOLTAGE RANGE = 150 V; level  $< 10^{-2} / fC$  for lower ranges. Example: for .01  $\mu$ F at 100 kHz, select 10 V max, on the 15-V range.

**2-TERMINAL X1.** Use 20 V rms, max, at this one setting of the TERMINAL SELECTOR. Otherwise, clipping circuits designed to protect you from a shock hazard will cause an error in your measurement.

**Resolution.** The chief reason for using a high voltage level is to facilitate balancing the bridge to a high resolution. Generally, make preliminary balances with 15 V or so.

Then switch to 50, and finally 150 V, as you refine the measurement beyond the 6th significant digit. **Do not exceed the voltage limits described above.**

**"Unknown"-Terminal Voltage.** If the TERMINAL SELECTOR is set to either of the X1 positions, the voltage across  $C_x$  is equal to the oscillator level, at moderate frequencies, at balance. Off balance, the terminal voltage varies from much less ( $C_x$  large and C levers set very low) to nearly twice the oscillator level (C levers set very high compared to  $C_x$ ).

If the TERMINAL SELECTOR is set to X10 or X100, the terminal voltage at balance is, respectively 1/10 and 1/100 of the oscillator level. Off balance, the maximum voltage at the UNKNOWN port is equal to the oscillator level. At frequencies much above 1 kHz, measure the terminal voltage, if you need to know it.

### 3.9 ACCURACY.

The 1616 Precision Capacitance Bridge will make measurements with internal standards to an accuracy of 1 part in  $10^5$  (10 ppm); it will make comparisons to 1 part in  $10^8$  (.01 ppm). However, such performance does not obtain for all combinations of frequency, "unknown"  $C_x$ ,  $G_x$ , ground capacitance, temperature, etc. Nor can the specified performance be expected unless the associated oscillator and detector are equivalent to those in the 1621 System.

#### 3.9.1 Accuracy vs. Frequency and $C_x$ .

Figure 3-6.

Refer to this figure for the specified accuracy as a function of test frequency and the magnitude of  $C_x$ . This plot shows at a glance that the bridge performs best at frequencies below a few kHz, less accurately at higher frequencies, particularly if  $C_x$  is much below 1 pF.

However, as the dashed lines in the lower right corner show, accuracy for small  $C_x$  is practically as good as it is for medium  $C_x$ , provided that each measurement is corrected by subtracting the "zero offset" or making it 0; see "zero adjust", para. 4.4.

**Zero Offset.** Determine the offset as follows:

- a. Disconnect the "unknown" capacitor; connect a shield (Table 1-4 "Open Circuit").
- b. Set TERMINAL SELECTOR to 3T X 1.
- c. Set C MAX to the lowest position.
- d. Balance the bridge carefully.
- e. The C readout is now the desired offset. Record and use it as a correction term, as described above.

**Resolution.** At the lower part of Figure 3-6, accuracy is limited by resolution. The limit is the smallest C-standard step, 0.1 aF or  $10^{-19}$  F, at frequencies above 1 kHz. As frequency is decreased below 1 kHz, and the oscillator voltage decreased (as discussed before), it becomes more and more difficult to determine that least-significant digit.

\*500V may be applied if GENERATOR and DETECTOR connections are interchanged (see 3.15).



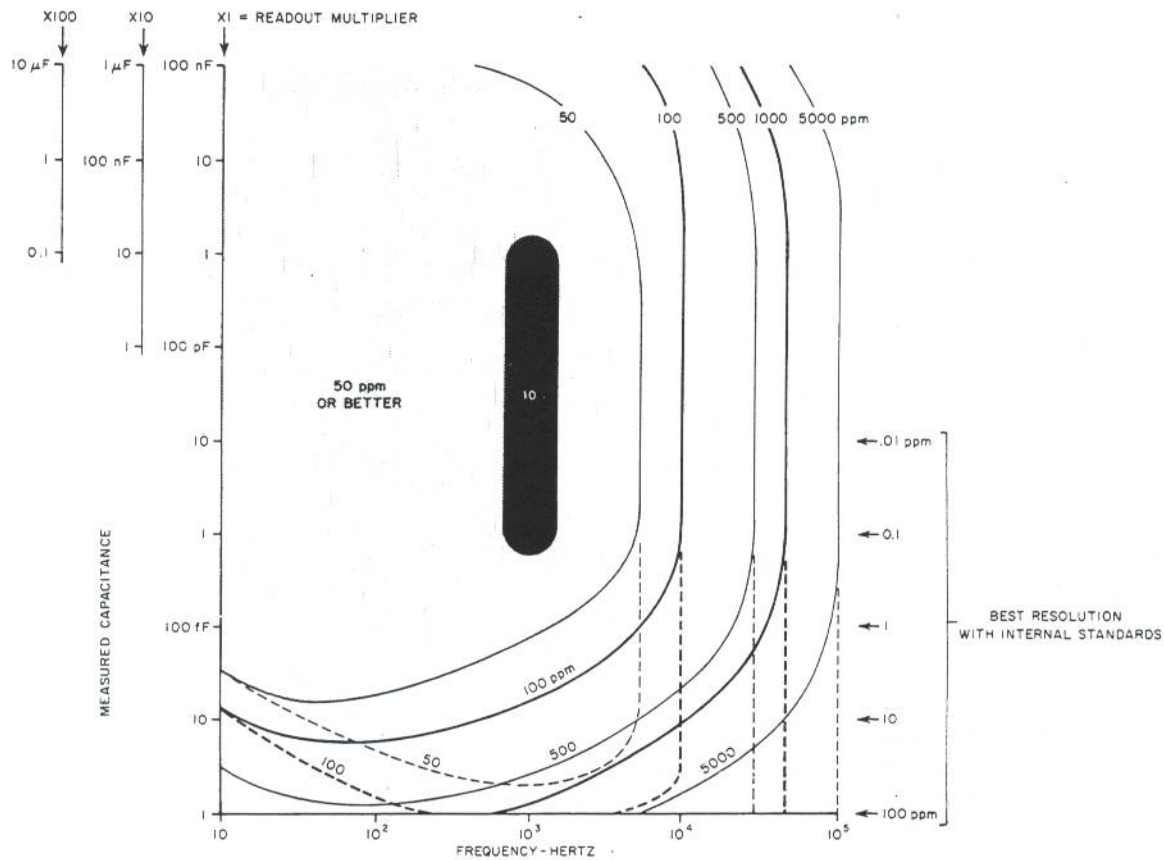

Figure 3-6. Specified capacitance accuracy of the 1616 Bridge. Dashed lines apply if readings are corrected by subtracting zero offset.

So the line of 50-ppm accuracy (for example) curves up to the left, from  $10^3$  Hz to 10 Hz.

**Errors from Ratio-Transformer Impedances.** The chief reason for the conspicuous reduction in accuracy at high frequency is the presence of leakage reactance (and winding resistance) in the ratio transformer. Refer to Section 4. Here are some salient conclusions, at high frequency:

1. Bridge readout is probably high if the READOUT MULTIPLIER is X10 or X100, low if X1.
2. Accuracy is best when READOUT MULTIPLIER is set to X1 and the most significant digit of readout is large (preferably X).
3. The specifications (and Figure 3-6) represent nearly "worst cases".

### 3.9.2 Accuracy vs. Temperature.

Figure 3-7.

Refer to this figure for an overall view of temperature effects on accuracy. Interpolate between 2 vertical lines if necessary. For example, in the central region (of greatest accuracy)  $28^\circ\text{C}$  is about 2/3 of the way from 0 to 25, say 16 ppm. If you are measuring  $C = 100$  pF at  $f = 1$  kHz and  $t = 28^\circ\text{C}$ , estimate the accuracy of the bridge thus: basic accuracy =  $\pm 10$  ppm (Figure 3-6); error due to temperature =  $\pm 16$  ppm (Figure 3-7); measurement accuracy =  $\pm 26$  ppm.

### NOTE

The term "steady-state temperature" is used in the figure as a reminder that the effective temperature of the internal standards can be known only if the ambient temperature has been constant for many hours.

For a more detailed treatment of temperature effects, calculate correction and tolerance as shown by the following example. Find the temperature coefficient  $\alpha$  of the most significant standard involved (from specifications or your own evaluation). The example is the same as in the paragraph above;  $\alpha$  is  $+3 \pm 1$  ppm/ $^\circ\text{C}$ .

a. Correction. Since  $t$  is  $5^\circ$  above bridge-calibration temperature, calculate the correction  $\alpha\Delta t = +3(5) = +15$  ppm. The standard capacitor is high, therefore the bridge readout is low.

b. Upper Bound. Since  $t$  is  $4^\circ$  above the upper bound of the basic-accuracy specification ( $\pm 10$  ppm from  $22$  to  $24^\circ\text{C}$ ), add to the basic accuracy  $\alpha\Delta t = +4(4) = +16$  ppm. The sum is  $+26$  ppm. (Assume the worst cases for  $\alpha$ :  $3+1$  for upper bound,  $3-1$  for lower bound,  $t$  being greater than  $23^\circ$ ; conversely for  $t$  less than  $23^\circ\text{C}$ .)

c. Lower Bound. Since  $t$  is  $6^\circ$  above the lower bound of the basic-accuracy specification, add to  $-10$  ppm the term  $\alpha\Delta t = +2(6) = +12$  ppm, i.e.,  $+2$  ppm.

In conclusion, the measurement in this example is: "readout" + 15 ppm, with a tolerance of  $+11, -13$  ppm. If

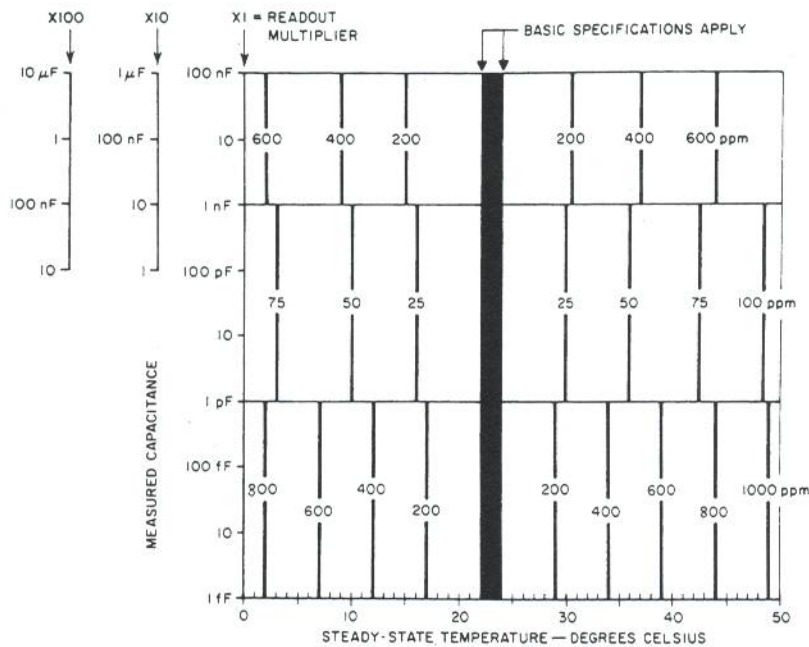

Figure 3-7. Worst-case measurement error due to temperature (based on maximum temp coef of C stds). Basic specifications apply in shaded band (23°C ± 1°C). In remainder of chart the error may add (in the worst case) to the tolerance given in Figure 3-6.

the readout were \*\* nF 103 pF 456 fF 789 aF, then the measurement would be: 103.4583 pF, +.0011, -.0013 pF

**NOTE**

If the bridge is to be used regularly at a temperature other than 23°C, it can be calibrated for such use. Refer to para. 5.4. For temperature rise in 1621 System, refer to Specifications, in front of manual.

**3.9.3 Range and Dissipation-Factor Limitations. Figure 3-5.**

**G-Range Limits.** The accuracy of a C<sub>x</sub> measurement may be limited by an extreme of G<sub>x</sub> (or vice versa). For example, if both C<sub>x</sub> and frequency are very large (near the limits specified for the bridge) and the capacitor is very lossy, the largest internal G standard may not be large enough for balance. Similarly, a very small C<sub>x</sub> with very low losses measured at a low frequency, may require smaller G-standard steps for the desired resolution than the smallest in the bridge. The simplest way to extend the range is by the use of external standards. The range limits are represented in the figure by the ends of C<sub>x</sub> and G<sub>x</sub> scales.

**Dissipation Factor.** Figure 3-5 covers somewhat more range of D than can easily be evaluated by this bridge. For moderate values, all the parameters discussed in paragraph 3.6 can be determined readily. However, at extremes of D (or Q), only the predominate admittance can be measured accurately.

**Very low D.** At about D ≤ 10<sup>-5</sup> the unknown capacitor has losses as low or lower than those of the internal stand-

ard capacitor. If, for example, D = 10<sup>-7</sup>, you cannot measure G<sub>x</sub> directly by the CONDUCTANCE readout, and so cannot measure D. However, this situation does not limit the C<sub>x</sub>-measurement accuracy, because any decade of the CONDUCTANCE standards can be set to -1.

**C-Accuracy with High D.** Because G standards have some stray C, C accuracy is sacrificed when much G has to be balanced. The error can be + or -, depending on certain compensations. Calculate accuracy as follows:

$$\frac{\delta C}{C} = \pm \frac{fD}{10^3 D_0} = \pm \frac{G}{2\pi 10^3 CD_0}$$

where D<sub>0</sub> is the ratio of conductance to 1-kHz susceptance of the G standards, and is 10<sup>3</sup> or more for this bridge.

Comparison accuracy depends on the G standards that are changed between measurements. Substituting ΔG for G in the formula, comp acc = ± ΔG / (2π10<sup>3</sup> CD<sub>0</sub>).

For example, if C<sub>1</sub> = 12.3456 pF, G<sub>1</sub> = 1.239 × 10<sup>-1</sup> μS and f = 500 Hz, then D = 3.2 and accuracy is ±1600 ppm. If a similar capacitor has C<sub>2</sub> = 12.3123 pF and G<sub>2</sub> = 1.241 × 10<sup>-1</sup> μS, then comparison accuracy is ±13 ppm. See also para. 4.7.

**3.9.4 Shunt Capacitances to Ground. Figures 3-1, 3-2.**

These capacitances, C<sub>ls</sub>, C<sub>hs</sub>, and C<sub>hg</sub> are excluded from the measurement of C<sub>x</sub>. However, if large, they can reduce accuracy and precision (particularly at high frequency).

If you can keep these capacitances below 200 pF each (unknown capacitor directly connected to bridge terminals)

or 100 pF plus cable capacitance (unknown capacitor connected by a pair of G874-R22LA patch cords) measurement accuracy is unimpaired, even at 100 kHz.

**Three-terminal Measurements.** If you must measure in the presence of larger shunt capacitances to ground, calculate a bound on the probable error as follows:

$$C_{\text{readout}} = C_x - \omega^2 C_{hs} C_{ls} L_{sg}$$

$$G_{\text{readout}} = G - \omega^2 C_{hs} C_{ls} R_{sg}$$

Notice that the error terms are both negative.  $C_{ls}$  is low-side-to-shield capacitance;  $C_{hs}$ , high-side-to-shield. Include cable capacitances, if patch cords are used.  $R_{sg}$  and  $L_{sg}$  are, respectively, the resistance and inductance of the path from a virtual common point in the shield surrounding the unknown capacitor to the ground point in the heart of the bridge. Include the R and L of the patch-cord outer conductors (2 in parallel, if 2 patch cords are used) in  $R_{sg}$  and  $L_{sg}$ .

As Figure 3-1 shows, our error calculation is based on a lumped-parameter situation. If cables are used, C, L, and R are really distributed along the cables, and the corresponding error terms are even less significant than those calculated above.

For example, assume shunt capacitance of 45 pF at each end of the unknown capacitor, in addition to 90 pF for each G874-R22LA patch cord. Assume 1  $\mu$ H and 10 m $\Omega$  for the series-impedance parameters of each cable and its associated connectors. Assume Frequency is 100 kHz. Then:

$$C_{hs} = C_{ls} = 1.35 \times 10^{-10} \text{ farad}$$

$$L_{sg} = 5 \times 10^{-7} \text{ henry}$$

$$R_{sg} = 5 \times 10^{-3} \text{ ohm}$$

$$C \text{ error} = \omega^2 C_{hs} C_{ls} L_{sg} = 3.6 \times 10^{-15} \text{ farad}$$

$$G \text{ error} = \omega^2 C_{hs} C_{ls} R_{sg} = 3.6 \times 10^{-11} \text{ Siemens.}$$

If  $C_x = 1$  pF, compare this C error with the normal error,  $5 \times 10^{-15}$  F. (Refer to Figure 3-6; measuring 1 pF, we expect 5000-ppm accuracy.) Notice that most of that error is due to series inductance in the bridge (see para. 4.7) and is accentuated by any inductance of the cable *inner* conductors. At lower frequencies, with very long cables, the series inductance thus usually contributes more error than the ground-return inductance.

**Two-terminal Measurements.** Non-coaxial 2-terminal measurements can be considered a special case of 3-terminal measurements in this aspect. If neither terminal has more than 200 pF to nearby instrument or bench "ground", and if that ground is connected by low impedance to the bridge

ground, the error from ground capacitance should be negligible.

Coaxial 2-terminal measurements differ in this aspect because the LOW bridge terminal is completely shielded by the HIGH. Capacitance from HIGH to ground does not affect accuracy except for loading of the ratio transformer. That effect is negligible for  $C_{hg} < 100$  pF or  $0.1 C_x$  (whichever is greater). However, a distinction must be made between  $C_{hg}$  and fringing capacitance; see below.

### 3.9.5 Fringing Capacitance.

Fringing capacitance is significant in coaxial 2-terminal measurements. (The HIGH and LOW connectors for 3-terminal measurements are far enough apart so the fringing between their inner terminals is only 125 aF.) As explained in paragraph 4.2, the recommended setting of ZERO ADJUST makes the balanced-bridge C readout express just the capacitance  $C_x$  due to fields beyond the reference plane of the G900 connectors, entirely within the "unknown" capacitor and its connector. As described in para. 3.4, you may assume the fringing is 0.115 pF and be correct within  $\pm .008$  pF, i.e., 8 fF. Two methods are suggested for greater accuracy, as follows.

**Standard Capacitor.** Use a Coaxial Capacitance Standard (2 pF) or (1 pF) with calibration specified within  $\pm 5$  fF, or a G900-W04 Precision Open-Circuit Terminal ( $2.670 \pm .0067$  pF). You may have one calibrated to greater accuracy by the National Bureau of Standards.

a. Set front-panel controls as of the completion of functional checks and phase adjustment, para. 3.2 and 3.3, at the desired frequency, para. 3.7.

b. Install the coaxial capacitance standard and set the CAPACITANCE lever switches to its value.

c. Set the TERMINAL SELECTOR to 2 TERMINAL X1, X10, or X100 depending on whether you wish to measure capacitors up to 1 nF, 10 nF, or 10  $\mu$ F, respectively. Keep the C MAX switch down, during this procedure (and during measurement of your unknown capacitors except when their values require large C standards with a READOUT MULTIPLIER of X100).

d. Balance the bridge, using the ZERO ADJUST control for C and the CONDUCTANCE lever switches for G. Turn the GAIN and SENSITIVITY controls as required for suitable indications of balance.

#### NOTE

The resolution of ZERO ADJUST settings is about 0.5 fF for X1 and X10, about 5 fF for X100 READOUT MULTIPLIER.

e. If you want to obtain a more exact value for the fringing of the G900 Connector on your bridge (for use in para. 3.4) remove the capacitance standard and rebalance the bridge using the CAPACITANCE lever switches. The

repeatability is about  $\pm 1$  fF; verify this by repeating the above procedure a few times.

**Direct Measurement.** Calibrate a coaxial 2-terminal capacitor against the internal bridge standards, if you prefer, by the method of Millea.\* (Refer to Appendix A.)

This method requires the capacitor to be measured twice, while attached to a fixture made with a tee, suitable connectors, and 2 lengths of flexible cable. The fixture is not readily available; details are left to your ingenuity.

### 3.9.6 Conductance Accuracy.

The accuracy specification is  $\pm 0.1\% \pm 1$  step in the least significant digit, particularly for  $G \cong 10^{-13}$  S. However, that last step need not be a limitation at larger conductance. If you avoid making the first digit of the CONDUCTANCE readout a zero:

$$G_{\text{readout}} = G_x \pm 0.1\% G_x; \text{ for } G_x \geq 10^{-5} \mu\text{S}$$

**Offset.** Measure  $G_0$  and use the correction, as follows.

a. With EXT MULTIPLIER OFF, TERMINAL SELECTOR at CAL, and readouts initially at zero, balance the bridge.

b. The G readout is  $G_0$ ; it may be + or -, with magnitude (typically)  $10^{-8}$   $\mu\text{S}$ . This offset is unaffected by ZERO ADJUST.

c. For any measurement in which  $G_0$  is significant (typically if the G multiplier is  $10^{-5}$  or  $10^{-6}$ ) subtract it from the readout, thus:

$$G_x = (G_{\text{readout}} \pm 1 \text{ in 5th window} - G_0) \pm 0.1\%$$

**Temperature.** The temperature effects on conductance accuracy are nearly negligible. The basic specification of  $\pm 1000$  ppm (see above) applies over the temperature range of  $23 \pm 1^\circ\text{C}$ . For further temperature changes, the worst case obtains when the CONDUCTANCE multiplier is set to  $10^{-4}$ ,  $10^{-5}$ , or  $10^{-6}$ ; then the readout at balance varies inversely with temperature at the rate of 700 ppm/ $^\circ\text{C}$ . For settings of  $10^{-4}$ ,  $10^{-3}$ ,  $10^{-2}$ ,  $10^{-1}$ , and 1, respectively, the temperature coefficients are: -700, -300,  $\pm 50$ ,  $\pm 50$ , and  $\pm 15$  ppm/ $^\circ\text{C}$ .

Of course, you can calibrate the bridge at a temperature other than  $23^\circ\text{C}$ , making use of the " $\pm 15$  ppm" internal standards or any suitable external standards for references. Refer to para. 5.4.

The internal conductance standards respond to environmental temperature change with a small time constant (a few minutes) in contrast to the large capacitance standards.

**C-Range Limits.** As discussed above (conversely),  $G_x$  accuracy may be limited by the available range of internal C

standards. For example, if  $G_x = 10^{-13}$  S and  $D = 10$  at  $f = 10^5$ , the smallest internal C standard is not small enough for a precise balance. (Stray C in the G standards has to be cancelled, so we are not able to *measure*  $C_x$  anyway.) If  $G_x = 10^{-4}$  S and  $D = 10^{-2}$  at  $f = 120$ , the largest internal C standard is not large enough for balance. Use an external standard, if you want to extend either limitation.

**Dissipation Factor.** At very large D, the unknown conductance may have less capacitance than the internal standard conductance. Then you cannot measure  $C_x$  directly and so cannot measure D. But (in contrast to small-D limits) this situation is generally no limitation on  $G_x$  measurement accuracy. C standards can be set negative if necessary for balance.

At very low D, the accuracy of  $G_x$  measurements is limited because a significant part of the conductance in the standard arm of the bridge consists of losses in the internal capacitance standards. It is therefore impractical to measure  $G_x$  in the region near or below the bottom edge of the chart Figure 3-5. If the low-loss C-standards are used ( $C_x < 1$  nF) this  $G_x$  accuracy limitation is 1% at  $D = 10^{-3}$ , 10% at  $D = 10^{-4}$ , and about 100% at  $D = 10^{-5}$ .

**Capacitance to Ground.** As explained in the  $C_x$ -accuracy discussion,  $G_x$  accuracy may be affected by the ground capacitance and series impedance from the shield around the unknown device through the cables to the bridge ground. If you must use long cables, and particularly if you need to test at high frequency, use the formula given there to estimate the consequent error:

$$G_{\text{readout}} = G_x - \omega^2 C_{hs} C_{ls} R_{sg}$$

### 3.10 PRECISION.

The comparison precision of the 1621 system (or the 1616 bridge if set up in an equivalent system) is specified to be  $\pm 0.1$  ppm (one part in  $10^8$ ) for low-loss capacitors between 10 pF and 10  $\mu\text{F}$ . This statement means that the system has the resolution, sensitivity, stability, repeatability, and operating convenience necessary for you to balance capacitance to  $\pm 0.1$  ppm.

Such precision is significant in measuring capacitance changes, comparing capacitors, adjusting and evaluating capacitance standards, etc. The precision is available for measurements described in preceding paragraphs, but far exceeds the absolute accuracy to which we can guarantee the many possible combinations of internal standards.

**Resolution.** The smallest internal-standard step is  $10^{-19}$  F, so resolution of  $\pm 0.1$  ppm extends from  $C_x = 10^{-11}$  F (10 pF) to  $10^{-5}$  F (10  $\mu\text{F}$ ) without external standards. An extra decade, at one end or the other of the range, can be provided by a suitable external standard.

**Sensitivity.** You can balance the 1621 system to  $\pm 0.1$  ppm because (among other things) you can see a .01 ppm unbalance on the detector. This remarkable sensitivity depends on instrument capabilities, but also on your selection

\*Millea, Aurel, "Connector Pair Techniques for the Accurate Measurement of Two-Terminal Low-Value Capacitances," *Journal of Research*, 3, of the National Bureau of Standards, Vol 74C, Nos 3&4, July-Dec, 1970.

of a high source voltage, proper tuning of the detector, and setting of the phase shift, as described before.

Because source voltage must be kept below a limit proportional to frequency, sensitivity is generally adequate for the above-mentioned resolution only at frequencies above about 900 Hz. These somewhat arbitrary limits obtain: at 10,  $10^2$ ,  $10^3$ ,  $10^4$ , and  $10^5$  Hz you can resolve to  $\pm 0.01$  ppm when  $C_x > 10^{-9}$ ,  $10^{-10}$ ,  $10^{-11}$ ,  $10^{-12}$ , and  $10^{-12}$  F, respectively. (To realize the  $10^{-12}$ -F limits requires not only the external standard mentioned under "resolution" but also, preferably, an external oscillator with a 350-V output.

**Stability.** You can enjoy the above-mentioned precision because (also) the internal standards which determine the most-significant digits of any such precise measurement are sufficiently stable. They are stable in terms of mechanical shock, aging, atmospheric changes, ambient temperature, and other factors.

Consider temperature in more detail. These standards are thermally isolated, with a time constant of 6 hours. Assuming you can make a comparison (2 measurements) in 6 minutes, the effect of a  $1^\circ\text{C}$  ambient temperature change on that comparison cannot exceed  $1/60$  of the specified temperature coefficient. That is  $3 \text{ ppm}/^\circ\text{C}$  for  $C_x$  in the range 1-1000 pF, so the effect is .05 ppm. Therefore, for  $\pm 0.01$ -ppm precision under these conditions, be sure the ambient temperature is regulated within  $\pm 0.2^\circ\text{C}$ .

#### NOTE

Because of the long thermal time delay in the bridge, it must be held at the desired temperature a long time before precise measurements can be made. Refer to para. 4.5 for a quantitative discussion.

For example, a  $12^\circ\text{C}$  change, 24 hours before, will disturb a comparison taking 6 minutes as much as a  $0.2^\circ\text{C}$  change during the comparison.

Take reasonable care to avoid mechanical shock, regulate temperature as described above, and you can rely on the stability of the internal standards, for  $C_x$  about 1-1000 pF. However, the internal 10 and 100-nF standards, used for  $C_x$  in the range of 2-100 nF, may have as much as an order of magnitude larger temperature coefficient.

To obtain .01 ppm precision using them, make more rapid comparisons, provide better temperature regulation, or use an unusually-stable external standard as described below under the heading of Externally Determined Accuracy.

### 3.11 EXTERNAL STANDARDS.

The 1616 Precision Capacitance Bridge has considerable versatility to make special measurements and comparisons in addition to those already described. These paragraphs deal with the use of external standards to extend range,

resolution, accuracy, and convenience of basic measurements.

An external standard of capacitance or conductance can be connected to the standard arm of the bridge through a ratio-selecting switch analogous to each of the capacitance lever switches. External and internal standards are often used at the same time.

#### 3.11.1 Range Extension to 111 $\mu\text{F}$ .

**Accessories.** A 1- $\mu\text{F}$ , highly stable, external standard, i.e., GR 1409-Y Standard Capacitor and two G874-R33 patch cords.

**Connections.** Connect the capacitor to the EXTERNAL STANDARD port of the bridge, thus: capacitor H to bridge HIGH, capacitor L to bridge LOW, and capacitor G to the shield of the LOW cable. Connect the unknown capacitor to its port as usual.

**Calibration.** Verify the calibration of the external standard with adaptors and cable at the frequency you plan to use, by the method of para. 3.4 and 3.5, or as follows: set EXT MULTIPLIER to  $-0.1$ , TERMINAL SELECTOR to CAL; balance the bridge; and multiply the CAPACITANCE readout by 10.

**Balance.** Measure the unknown capacitor as usual except that you now have a more-significant C digit than before, controlled by the EXT MULTIPLIER switch.

**Readout.** If the external standard is 1  $\mu\text{F}$ , with sufficient accuracy for your measurement, and if the series-inductance error described below is tolerable, interpret the EXT MULTIPLIER setting *multiplied by 10* as an extra digit at the left of the usual C readout. (Example: ext std value: 1.00011  $\mu\text{F}$ ; EXT MULT: 0.6; readout: 54 nF 321 pF . . . ; READOUT MULT: X100; desired accuracy:  $\pm 0.1\%$ . Final value is 65.4  $\mu\text{F}$ .)

But if you want greater accuracy, the measurement is: [(external standard C value) (EXT MULTIPLIER) + CAPACITANCE readout] (READOUT MULTIPLIER) - (series-inductance correction). In the same example:  $(1.00011 \times 0.6 + .054321) \times 100 = 65.4387 \mu\text{F}$ , without the correction (see below). In this example, that might be .05  $\mu\text{F}$ . Unless you can refine that, only 2 decimal places are valid. Then the final measurement is:  $65.44 - .05 = 65.39 \mu\text{F}$ .

Similarly, the final G readout is: [(external standard G value) (EXT MULTIPLIER) + (CONDUCTANCE readout) (CONDUCTANCE multiplier)] (READOUT MULTIPLIER).

**Series-L Correction.** The accuracy of measurement of large capacitance is usually limited by the bridge and lead inductance in series with the capacitance. The bridge reading of capacitance is greater than the unknown capacitance  $C_x$  by a capacitance error  $\Delta C = \omega^2 C^2 \ell$ . If bridge induc-

tance  $\ell$  is about  $0.3 \mu\text{H}$ , in series with the UNKNOWN terminals, you have a minimum error of the order of  $+0.002\% C_{\mu\text{f}} (f_{\text{kHz}})^2$ . Hence, at 1000 Hz and  $100 \mu\text{f}$ , the bridge reading might be high by about 0.2%. Refer also to para. 4.7.

### 3.11.2 Extension of C Resolution.

Although the resolution of the bridge is exceptionally fine, you can make it still finer with a sufficiently small external capacitance standard. Thoroughly shield anything connected to EXTERNAL STANDARD port, particularly on the LOW side.

Accessories. A well-shielded  $0.1\text{-aF}$  (i.e.,  $10^{-19}\text{F}$ ) 3-terminal capacitor; well-shielded cables, such as 874-R22LA.

#### NOTE

If you make such a capacitor, use button-sized plates spaced several cm either side of a shield with a small pinhole in the center.

Zero Adjust. If the measurement is to be made at the 3-TERMINAL port, shield the 3-T LOW connector using an open-circuit termination; set TERMINAL SELECTOR to 3-T X1, C MAX lever down, and the entire C readout to zero. Balance the bridge with ZERO ADJUST and the G lever switches. [If the measurement is to be 2-terminal, omit the shield, install a coaxial C standard, set TERMINAL SELECTOR accordingly, and balance the bridge with the C readout fixed at the value of the C standard.]

Calibration. Measure the external standard at the EXTERNAL STANDARD port. A balance should obtain with C readout set to  $0.1 \text{ aF}$ , EXT MULTIPLIER to 1.0. [If the measurement is to be 2-terminal, set the C readout  $0.1 \text{ aF}$  above the value of the C standard.] Use a high frequency (10-100 kHz) and high oscillator level. Measurement precision of  $\pm 10\%$  is probably adequate. (Setting the EXT MULTIPLIER to 0.9 should noticeably unbalance the bridge.) If possible, *adjust the external standard* to  $0.1 \text{ aF}$ .

Balance. Connect the unknown capacitor to its port. Measure as usual except that you now have a less-significant C digit than before, controlled by the EXT MULTIPLIER switch.

Readout. Interpret the EXT MULTIPLIER indication *multiplied by 10* as an extra digit at the right of the usual C readout. (Example: ext std value:  $0.1 \text{ aF}$ ; EXT MULT: 0.6; readout:  $234 \text{ aF}$  5; READOUT MULT: X10. Final value is  $2.3456 \text{ fF}$ .)

### 3.11.3 Externally Determined Accuracy / Comparisons.

Applications. If you want to make a series of measurements with the convenience of direct readout but with

greater accuracy than the internal standards permit, and if you have suitable external standards, use this procedure. (For example: the bridge may not yet be stabilized at room temperature.) Alternatively, you may wish to measure against a standard deliberately set a few ppm different from the internal standards.

Comparisons between external standards of the same nominal value, or values differing by convenient ratios, like 1, 2, or 10, can be made to great precision (para. 3.10). Use one as "standard", one as "unknown." As a check on possible zero offset, interchange them and compare again.

Accessories. A suitable reference, i.e., GR 1404-A, and 2 of G874-R22LA patch cords.

Connections. External standard capacitor to EXTERNAL STANDARD port; H to HIGH, L to LOW. Unknown capacitor to its port.

Balance. Measure as usual, except be sure to control the most significant digit by the EXT MULTIPLIER switch. Notice which C-lever switch (call it S) corresponds in magnitude to the EXT MULT. Set "S" and all at its left to zero. For good external determination of accuracy, EXT MULT should be set high, and one or more levers right of "S", low (preferably zero).

(Example: Ext std:  $100 \text{ pF}$ ; "S" is the  $10\text{-pF}$  lever, regardless whether READOUT MULT is 1X or higher. Note: "S" set to X would represent  $100 \text{ pF}$ ; and so would EXT MULT set to 1.0.)

Readout. Read out as usual except that EXT MULTIPLIER reading *multiplied by 10* must be substituted for the zero of lever switch "S." (Example, as above, also: EXT MULT: 0.8; READOUT MULT: 10X; C readout:  $123 \text{ fF}$  456 aF. Final value is  $801.23456 \text{ pF}$ .)

Accuracy. Estimate the C and G accuracies by adding these error contributions for each:

1. Error in calibration of the external standard capacitor, ppm.
2. Error of internal standards as they apply: (refer to para. 3.9) express temporarily as C or G (not ppm) and multiply by the indicated READOUT MULTIPLIER. Express result as ppm of the "final value".
3. Error of ratio transformation. Typically:

error is <	1	3	10	ppm
for ratio:	1	10	100,	

where the ratio is the product of EXT MULTIPLIER and READOUT MULTIPLIER settings. Ratio of 1 must be (1.0) (X1) not (0.1) (X10).

4. Error of zero offset. Bridge reading at balance with both ports open but shielded (use a G874-W) Termina-

tion on each LOW connector), EXT MULTIPLIER at 1.0, and READOUT MULTIPLIER at X1. This error should be zero.

#### 3.11.4 Test-Fixture Compensation.

Applications. You may have a test fixture, leads, terminals, etc. which have parameters included in  $C_x$  and  $G_x$  but which you want to balance separately so that the bridge readout is only the *additional* C and G of capacitors connected to the fixture.

Notice that ZERO ADJUST performs just this function for 2-TERMINAL measurements only, for C only, and for a very limited range, but with great precision. (Its function, specifically, is to balance the capacitance of the G900 connector on the bridge.)

Accessories. Stable, adjustable, 3-terminal shielded, precision capacitor and (optionally) a conductance, i.e., GR1422-CB capacitor, and two G874-R33 patch cords. (Adjustable conductance standards, though not usually needed, may be connected in parallel.)

Connections. Connect the test fixture you plan to use to the appropriate UNKNOWN port; the compensating capacitor (and conductance, if any) to the EXTERNAL STANDARD port. Set the READOUT MULTIPLIER as you intend to keep it for subsequent measurements.

Adjustment. With the C and G lever switches set to zero and EXT MULTIPLIER on 1.0 (or a lower setting) balance the bridge by adjustment of the external standard. If that is only capacitive, manipulate the CONDUCTANCE lever switches as usual.

Notice that it is quite possible to make satisfactory test-fixture compensation without reaching a perfect balance with the external standard. For example, suppose you need to compensate about 20 pF; READOUT MULT: X1; available capacitor range: 10 to 110 pF. Set EXT MULT to 0.2. This capacitor has a resolution better than 4 fF, i.e.,  $< 1$  fF, referred to the test fixture. If that resolution is sufficient, simply verify that you have achieved it. (Refine the balance using C lever switches and verify that appreciably *less* than  $\pm 0.5$  fF is required of them.)

If, in that example, resolution must be 10 aF, you need another external variable standard capacitor in parallel with a suitable fixed capacitor.

#### 3.11.5 Range Extension to 11 mS.

Accessories. A standard 10-k $\Omega$  resistor and two G874-R33 patch cords (or one cord and G874-MB adaptor).

General Procedure. Refer to the analogous paragraph 3.11.1, which concerns C rather than G. The readout for-

mulae for C and G are both given there. The "external standard G value" is 100  $\mu$ S.

#### NOTE

External standards of C and G can be used simultaneously by connecting them in parallel.

### 3.12 PRECISE COMPARISONS.

#### 3.12.1 Balance Comparisons.

Very precise comparisons between 2 capacitors nominally related by convenient ratios, such as 1, 2, or 10, can be made by connecting one as EXTERNAL STANDARD, the other as UNKNOWN capacitor. The internal standards are used only to evaluate the difference. Refer to para. 3.11.

#### 3.12.2 Direct Substitution.

Even more precise comparisons between 2 nominally equal capacitors can be made by connecting them sequentially as the UNKNOWN capacitor. External standards may be used.

Balance Technique. Make use of (-1) and X settings of lever switches if doing so will permit more of the most-significant digits to remain unchanged. Example: if capacitor A measures 12345.0012+ pF, and B something more like 12344.9998+ pF, then make the readouts 12 nF 345 pF 001 fF 255 aF and 12 nF 345 pF 00(-1) fF 855 aF respectively.

Repeat measurements A, B, A, B, etc. to eliminate any effects of temperature changes, connector reliability, etc. In this example, then, B is .0014 pF, i.e., 0.12 ppm, less than A.

Precision. The only limit on how precisely a pair of capacitors can be matched is the resolution of the bridge. The errors listed in para. 3.11.3 do not apply; absolute "farad" value is of secondary importance. If A and B are so similar that each can be balanced repeatedly with the same 9 most-significant digits, and if the 9th digit is significant (changing it upsets the balance) then you may be sure that A and B are equal (for the moment) within  $\pm 0.001$  ppm. Generally, comparison precision is specified at  $\pm 0.01$  ppm for the 1621 system. Refer to para. 3.10.

Terminal Capacitance. Terminal, fringing, and test-fixture capacitances cancel in direct-substitution measurements, a fact that makes this method convenient for many kinds of 2-terminal measurements, even when great precision is not required. Refer to para. 3.13.

### 3.13 NON-COAXIAL 2-TERM. CAPACITORS. Figure 3-8.

Measurement of non-coaxial 2-terminal capacitors can be precise and repeatable only to the extent that the various stray admittances can be brought under control. Some can be excluded from the measurement, some need to be included. Some are unavoidably influenced by the method of

connection to the bridge, and so the measurement is valid only if such details are specified.

The capacitor terminals are represented in a general way. If they are a pair of binding posts at standard spacing or a coaxial connector and if the bridge UNKNOWN port can be adapted to mate with these terminals, the method of connection can be specified reasonably well.

### 3.13.1 Unshielded, 2-Terminal Capacitors. Figure 3-8a.

Diagrammed is a very simple capacitor, with an internal capacitance  $C_{10}$ .  $C_{40}$  represents capacitance between the terminals;  $C_{20}$  and  $C_{30}$  capacitances to the nearest conductor in the environment (we assume for simplicity, there is only one such conductor of importance).

**Intrinsic Value.** As it stands alone, the capacitance of diagram a is:

$$C_{10} + C_{40} + \frac{C_{20} C_{30}}{C_{20} + C_{30}}$$

**Connections.** If the capacitor has a G874 connector or 1.75-inch-spaced binding posts, use a G900-Q874, or G900-Q9 adaptor, respectively. A length of cable or rigid coaxial line can be used to locate the point of attachment away from the bridge. Other capacitors (in general) will require special adaptors or test fixtures.

**Measured Values.** When you connect that capacitor to the 2-TERMINAL port of the bridge, all the strays change. Diagram b shows a wire used to make connection at one terminal. Even if you properly adapt the bridge port so the capacitor mates without such a wire,  $C_{40}$  is now different, i.e.,  $C_{41}$ .  $C_{21}$  is certainly larger than  $C_{20}$ .  $C_{30}$  may be practically unchanged.  $C_{50}$  is capacitance from that "nearby conductor" to bridge ground.

Because  $C_{21}$ ,  $C_{31}$ , and  $C_{50}$  form a Y network with a midpoint that we don't care about, we can substitute the equivalent  $\Delta$ . (Use a Y- $\Delta$  or T- $\pi$  transformation.) Two parts of the  $\Delta$  are excluded from the measurement.\* The third part, across the bridge LOW and HIGH terminals, is:

$$C_{235} = \frac{C_{21} C_{31}}{C_{21} + C_{31} + C_{50}}$$

Certainly, if we make  $C_{50}$  large enough with respect to  $C_{21}$  and  $C_{31}$ ,  $C_{235}$  will approach zero. If  $C_{50}$  is small enough,  $C_{235}$  approaches  $C_{21} C_{31} / (C_{21} + C_{31})$ .

As represented by diagram b, the measured value is:

$$C_{10} + C_{41} + C_{235}$$

It is usually preferable to make the third term zero rather than try to make it approximate the third term in the "intrinsic value." If you do the former, by grounding any nearby conductors (diagram c) the measured value is:

$$C_{10} + C_{41}$$

\*Because the 1616 circuitry is basically a 3-terminal bridge with ground as guard.

**Correction for Cable, Connector, etc.** There are 2 distinct methods of removing adaptor capacitance from your measurement (results differ). For each method, there are 2 techniques (results are identical).

**Open-Connector Method.** Be sure there is nothing but air at the connector or fixture to which the capacitor will be connected. The 2 equivalent techniques are:

1. Use an external standard and/or ZERO ADJUST to balance the bridge with zero CAPACITANCE readout (ref. para. 3.11). Now when you measure an unknown capacitor, the readout is the corrected measurement. Alternatively:

2. Balance the bridge and record the readout  $C_{OF}$ , the capacitance of adaptor, cable, and fringing. Now when you measure an unknown capacitor, correct your measurement as follows: "readout" minus  $C_{OF}$ . (Refer to para. 3.9.5 for more about fringing.)

**Substitution Method.** Connect a standard capacitor  $C_s$  with the same terminal configuration as the unknown to the test point. The 2 techniques are:

1. Use an external standard and/or ZERO ADJUST to balance the bridge with CAPACITANCE readout set to  $C_s$ . Now when you measure an unknown capacitor, the readout is the corrected measurement. Alternatively:

2. Balance the bridge and record the readout  $(C_s + C_o)$ . Refer to para. 3.12. Now when you measure an unknown capacitor, correct your measurement as follows: "readout" plus  $C_s$  minus  $(C_s + C_o)$ .

#### NOTE

If the standard used in the substitution method was calibrated to eliminate fringing and  $C_{40}$ , the corrected measurement is  $C_{10}$ .

**Use the 3-Terminal Port** (Figure 3-8, d). If you wish to measure, as directly as possible, the internal capacitance  $C_{10}$ , make a separate, shielded connection to each terminal. Make connections (if the capacitor has a pair of binding posts) with a pair of G777-Q3 adaptors and a pair of G874-R22LA cables. Connect only the shielded plug of each G777-Q3 to the capacitor. Ground any nearby conductor as shown. If the shields extend far enough,  $C_{42}$  will certainly be less than  $C_{40}$ . The measured value is:

$$C_{10} + C_{42}$$

#### NOTE

As a rule, this bridge readout is valid without correction for cable and adaptor capacitances, although either method described above may be used for greatest accuracy.

### 3.13.2 Shielded 2-terminal Capacitors. Figure 3-9, e.

These capacitors are enclosed in a conducting shield; examples are GR 1409-Y, or 1422-D. Some may alternatively be measured as 3-terminal capacitors (refer to



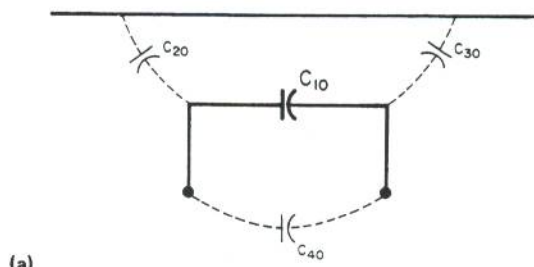

(a)

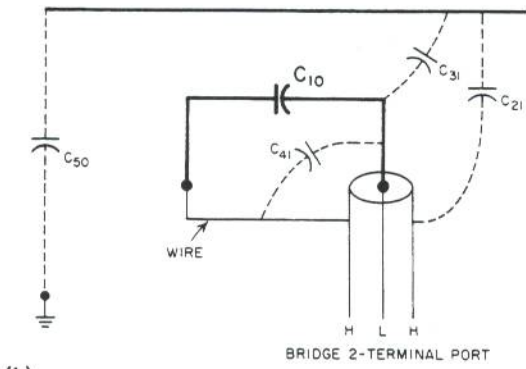

(b)

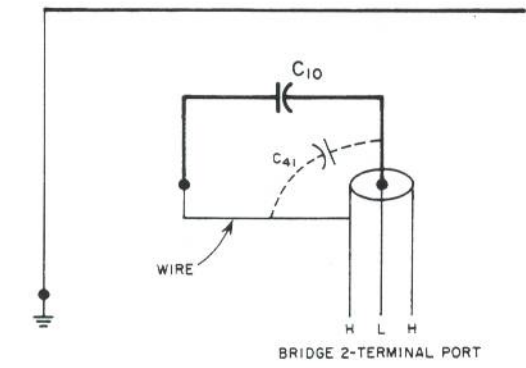

(c)

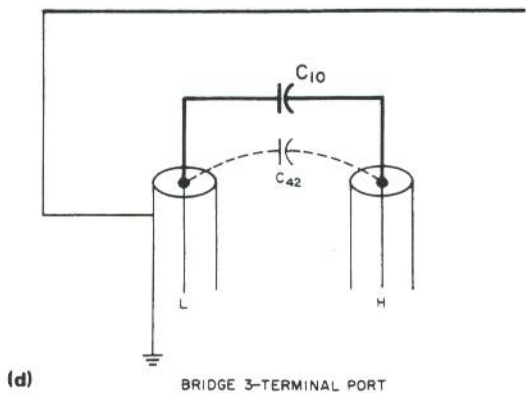

(d)

Figure 3-8.

Non-coaxial 2-terminal capacitors and some measurement configurations.

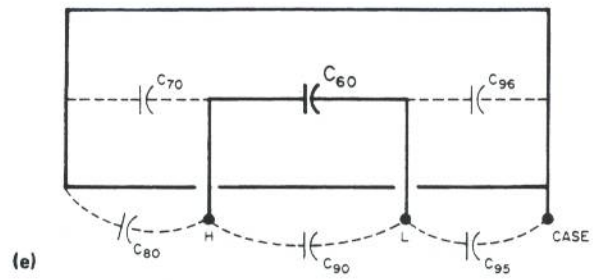

(e)

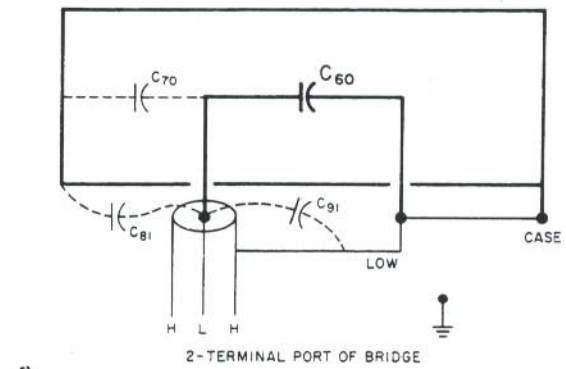

(f)

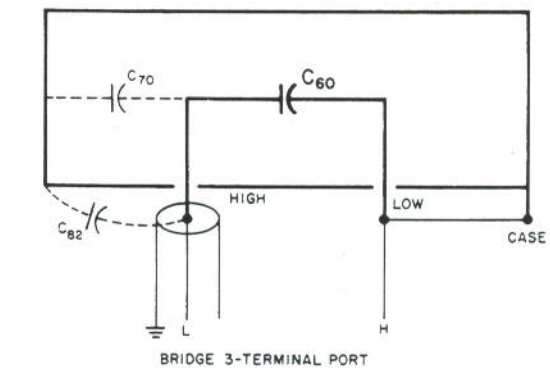

(g)

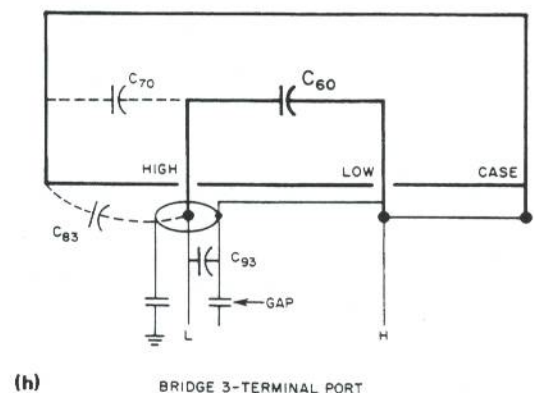

(h)

Figure 3-9.

1616 24

para. 3-4). Others may have one terminal already connected to the shield.

**Intrinsic Value.** As it stands alone, the capacitance of diagram e is:

$$C_{60} + C_{90} + \frac{(C_{70} + C_{80})(C_{95} + C_{96})}{C_{70} + C_{80} + C_{95} + C_{96}}$$

However, we are specifically interested in 2-terminal value, with one terminal connected to the case. Assuming the right-hand terminal is the one, then the intrinsic capacitance reduces to:

$$C_{60} + C_{70} + C_{80} + C_{90}.$$

**Connections.** Connect the LOW terminal to the GND or shield terminal using a link, 938-L, if it fits. Connect the 2 capacitor terminals to the 2-TERMINAL UNKNOWN port of the bridge as follows: capacitor LOW to bridge outer (HIGH); capacitor HIGH to bridge inner (LOW). If the capacitor terminals are 1.75-inch-spaced binding posts, use G777-Q3 and G900-Q874 adaptors and, if desired, a shielded cable (G874-R22LA). Alternatively, use only the link and a G900-Q9 adaptor.

**Measured Value.** When you connect that capacitor to the bridge at least 2 of the strays change.  $C_{80}$  is probably reduced (by shielding) to  $C_{81}$ ;  $C_{90}$  changes completely (now that LOW and GND are connected) to  $C_{91}$ .

As shown by Figure 3-9, f, the measured value is:

$$C_{60} + C_{70} + C_{81} + C_{91}.$$

#### NOTE

Correct the bridge readout for cable and adaptor capacitance, as described before.

**Use the 3-Terminal Port, Simply** (Figure 3-9, g). If you wish to make virtually the same measurement without the need to correct for cable and adaptor capacitances, proceed this way.

a. Connect LOW to shield or GND of the capacitor with a link as before.

b. Install a G874-MB adaptor at the bridge 3-TERMINAL HIGH connector. Tie that to the capacitor LOW with a wire or plain patch cord.

c. Connect the G777-Q3 adaptor shielded plug only to the capacitor HIGH terminal. Tie that to the bridge 3-TERMINAL LOW connector using a shielded cable, G874-R22LA. Be sure the shield of the G777-Q3 adaptor does not contact the shield surrounding the capacitor. Make a washer of paper or plastic (.003 to .015 in. thick) for this purpose.

d. Your measured value (diagram g) is:

$$C_{60} + C_{70} + C_{82}.$$

(where  $C_{82}$  is comparable to  $C_{81} + C_{91}$  of diagram f.)

**Use the 3-Term. Port, with Correction** (Figure 3-9, h). Some capacitors are specified in terms of the capacitance added to a given bridge port (Adapted, if necessary, to suit the capacitors). For example the 2-terminal capacitances of certain GR 1422 capacitors are so defined. A typical procedure follows:

a. Install a 938-L link on the capacitor-case (GND) binding post, connecting also to the adjacent LOW post, if any.

b. Install a G777-Q3 adaptor on the capacitor - insulated plug at capacitor HIGH, shell connected plug at the adjacent bind post with the link.

c. Install a G874-MB Coupling Probe as an adaptor on top of the G777-Q3. Unscrew the binding post just installed, far enough to determine the gap as follows:

d. Install another G777-Q3 (shielded plug only) on top of the stack. With it firmly seated, verify that a 1/16-in. gap (2 mm or less) exists between the shields.

#### NOTE

This gap is the demarkation between part of the adaptor stack included in  $C_{93}$  and part that is not. To stabilize the gap, wrap assembled adaptors tightly with electrical tape.

e. Connect the top adaptor to the bridge 3-TERMINAL UNKNOWN, LOW using a shielded cable, G874-R22LA.

f. Install another G874-MB adaptor at the 3-TERMINAL UNKNOWN, HIGH connector. Tie this, using a patch cord or wire, to the link in step a. (If the capacitor has only 2 binding posts, fasten to the link with an alligator clip; otherwise, use the 3rd binding post.)

g. Temporarily unplug the first G777-Q3 adaptor from the capacitor binding posts and support it nearby with the inner, insulated plug exposed. Tie the shell-connected plug (uninsulated) to the capacitor-case binding post (bridge HIGH) as before.

h. Compensate the bridge by the open-connector method (technique 1 or 2) described above. This step eliminates  $C_{93}$  (diagram h) from your measurement.

i. Reinstall the first G777-Q3 adaptor as in step b. Measure the unknown capacitor as usual.

j. Your measured value (diagram h) is:

$$C_{60} + C_{70} + C_{83}.$$

### 3.14 DC BIAS.

Dc bias voltage may be applied in either of two ways to a capacitor that is being measured on the bridge.

⚠  
**CAUTION**

Do not apply voltage at the bridge DETECTOR OUTPUT connector in excess of  $E_{MAX}$  in Table 3-2, or the G standards may be damaged

A recommended power supply is the GR 1265-A.

⚠  
**WARNING**

- To minimize electrical shock hazard, limit bias to 60 V.
- Bias voltage is present at connectors, test fixtures and on capacitors under test.
- Capacitors remain charged after measurement.
- Do not leave instrument unattended with bias applied.
- To remove the risk of electric shock, turn the voltage source to "0" before connecting or disconnecting the device under test.

It should be noted that the instrument is rated to accept bias voltages up to 500 V rms or dc. However, to minimize the risk of electrical shock hazards, the use of biasing voltages of less than 60 V is highly recommended.

**3.14.1 Normal Bridge Configuration / Parallel Bias. Fig. 3-10.**

To apply bias in parallel with the detector:

- a. Connect the bridge as usual, but add the dc bias supply in parallel with the detector, as shown in the circuit of Figure 3-10.
- b. Shield all leads connected to the high side of the detector. Use a G874-T tee connector for convenient parallel connections and a G874-QBJA Adaptor.
- c. If your detector is not the GR 1238, connect a series capacitor between detector input and bias supply to block bias voltage from the input stage. (This capacitor is built into the detector input stage of the 1238.)
- d. Connect a series resistor  $R_B$  between the high lead in the tee and the bias supply to prevent the low impedance of the bias supply from shorting the detector input. A resistance of about 100 k $\Omega$  is recommended. Lower resistance reduces the detector sensitivity; higher resistance reduces the dc voltage across the unknown capacitor since:

$$E_X = \frac{E_B R_{BD}}{R_B + R_{BD}}$$

Refer to Table 3-2 for the effective bridge resistance  $R_{BD}$  at the DETECTOR OUTPUT connector. Install the resistor in a shield such as a G874-X Insertion Unit.

NOTE

Use a choke in place of  $R_B$  for high ac impedance, when low dc-voltage drop is needed. Shield the choke from both magnetic and electric fields.

- e. Connect the unit holding  $R_B$  to the tee, and that to the DETECTOR OUTPUT connector of the bridge, using an adaptor (G874-QBPA).

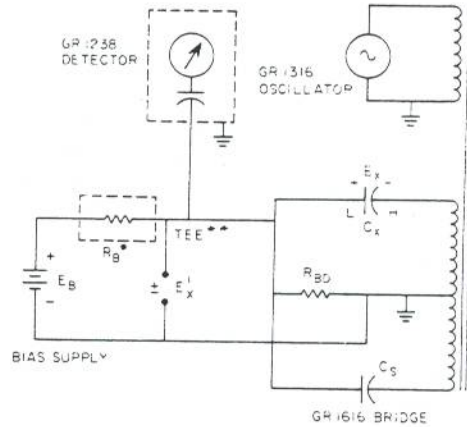

**Figure 3-10. Circuit for applying bias to the unknown capacitor – normal configuration. Notes: \*Resistor in G874-X Insertion Unit; G874-Q2 Adaptor provides binding posts for power supply. \*\*G874-T tee with G874-QBJA and G874-QBPA Adaptors to BNC connectors.**

- f. Either polarity of dc bias can be applied. Choose the polarity required by the capacitor being tested. Observe the current limitations described below.

- g. Calculate the bias from a known  $E_B$ , using the formula in step d.

**3.14.2 Reversed Bridge Configuration / Series Bias. Fig. 3-11.**

Compared to the normal configuration, this method allows higher oscillator voltage to be applied at low frequencies (unless the CONDUCTANCE multiplier must be set very high); has lower sensitivity; and permits direct bias measurement. In the reversed configuration, you apply bias in series with the oscillator; use the following procedure:

- a. Connect the bridge "reversed"; refer to para. 3.15.
- b. Connect the dc bias supply or battery in series with the oscillator.
- c. Observe the current limitations described below.

Table 3-2

CHARACTERISTICS AT BRIDGE DETECTOR-OUTPUT CONNECTOR		
CONDUCTANCE Multiplier	$E_{MAX}^*$	$R_{BD}$
1	70 V	9 k $\Omega$
$10^{-1}$	210	89
$10^{-2}$	500	810
$10^{-3}$	500	8 M $\Omega$
$10^{-4}$ , $10^{-5}$ , or $10^{-6}$	500	80

\*Volts rms or dc.

d. Calculate the bias from a known  $E_B$ , using the formula given above, except that  $R'_B$  depends on the settings of FREQUENCY range and OUTPUT VOLTAGE RANGE on the 1316 Oscillator. ( $R'_B$  can be as large as 2.4 k $\Omega$ .) Alternatively, measure  $E_x'$  (Figure 3-11).

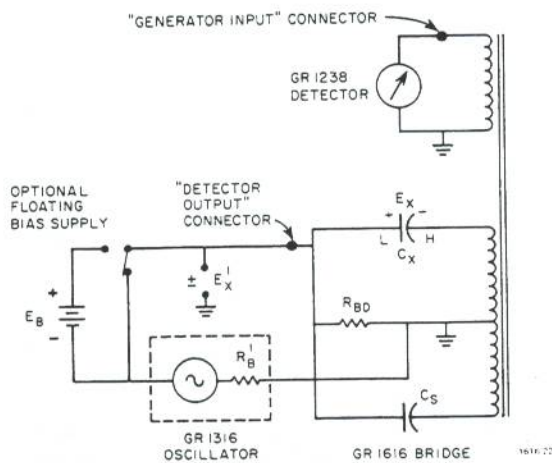

Figure 3-11. Reversed configuration – bridge circuit with oscillator and detector interchanged, showing optional application of bias to unknown capacitor.

### 3.14.3 Dc in the Ratio Transformer / Demagnetization.

When the capacitor that is measured with bias (by either of the preceding configurations) passes leakage current, dc will flow through the bridge ratio transformer. This current will magnetize the core and affect the accuracy of the ratios, and such use generally is not recommended. It is, however, possible to operate the bridge with some dc in the transformer, if you keep this current below the  $I_{MAX}$  values shown in Table 3-3 to avoid saturation of the core. Operation within these limits will not damage the bridge, but demagnetize the transformer after such use to insure accuracy in normal operation. Demagnetize as follows:

- Connect oscillator to bridge in the normal configuration.
- Set oscillator FREQUENCY to 100 Hz, OUTPUT VOLTAGE RANGE to 50, OUTPUT ADJUST to zero. Set bridge TERMINAL SELECTOR to CAL.

c. Turn the oscillator OUTPUT ADJUST cw to MAX and then slowly ccw to zero again.

### 3.15 REVERSED CONFIGURATION.

Figure 3-11.

#### 3.15.1 Explanation.

To apply higher ac test voltage (up to 500 V) to the unknown capacitor than that normally permitted, use this configuration, in which the oscillator is connected to the bridge DETECTOR OUTPUT connector and the detector is connected to the bridge GENERATOR INPUT. Use this reversed configuration when lower sensitivity can be tolerated.

In normal operation, the maximum voltage across the unknown capacitor would be limited by transformer-core saturation to  $E_{MAX} = 0.16 f$  (para. 3.8). However, in reversed operation, the maximum voltage is limited by power dissipation in bridge resistors, or by insulation breakdown. The former depends on the CONDUCTANCE multiplier setting – refer to  $E_{MAX}$  in Table 3-2.

When the configuration is reversed, the ac test voltage across the unknown capacitor is equal to the generator voltage at balance, or between zero and twice that voltage for any unbalance.

#### 3.15.2 Procedure.

- Interchange 2 connections at the rear of the bridge (Figure 1-3) so you have: oscillator POWER OUTPUT tied to bridge DETECTOR OUTPUT and bridge GENERATOR INPUT tied to detector INPUT SIGNAL.
- Balance the bridge as usual (para. 3.5) but observe the limits of Table 3-2 instead of para. 3.8.

Table 3-3  
BIAS CURRENT LIMITS FOR  
TRANSFORMER SATURATION

READOUT MULTIPLIER	$I_{MAX}^*$
X 100	200 mA
X 10	20
X 1	2

\* An elastic limit – for best resolution these values are too high; for some measurements, currents of 5  $I_{MAX}$  may be tolerable.

# Theory – Section 4

4.1 INTRODUCTION	4-1
4.2 PROPERTIES OF CAPACITORS	4-1
4.3 BASIC BRIDGE CIRCUITRY	4-5
4.4 CIRCUITRY OF THE 1616 BRIDGE	4-7
4.5 C-STANDARDS ACCURACY	4-9
4.6 G-STANDARDS ACCURACY	4-10
4.7 RATIO ACCURACY	4-11

## 4.1 INTRODUCTION.

The 1616 Precision Capacitance Bridge is a standards-laboratory instrument of exceptionally high precision. Together with the other components of the 1621 Precision Capacitance-Measurement System, it is designed for accurate measurements of capacitance, conductance, and therefore the properties of dielectrics, as well as high-resolution comparisons among capacitance standards.

This section deals with the 1616 bridge. For theoretical discussions of the 1316 Oscillator and 1238 Detector, please refer to their individual instruction manuals.

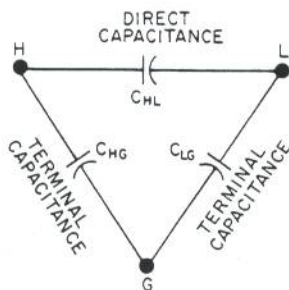

Figure 4-1. Schematic diagram of a capacitor, showing the direct capacitance and the associated terminal capacitances.

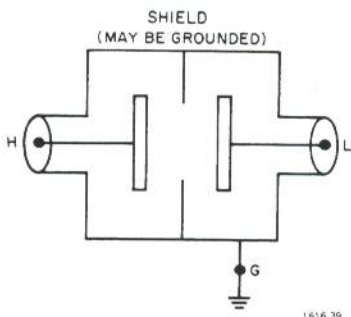

Figure 4-2. Structure of a 3-terminal capacitor with 2 coaxial connectors.

## 4.2 PROPERTIES OF CAPACITORS.

### 4.2.1 Basic Components of Capacitance.

Figure 4-1.

**Three Terminals.** Most physical capacitors can be precisely represented by the three capacitances shown in Figure 4-1: the direct capacitance,  $C_{HL}$ , between the terminals H and L (capacitance between the plates of the capacitor), and the two terminal capacitances,  $C_{HG}$  and  $C_{LG}$ , from the corresponding terminals and plates to the case, surrounding objects and ground (to which the case is connected to either conductively or by its relatively high capacitance to ground).

A 3-terminal capacitor (Figure 4-2) has connected to the G terminal a shield that completely surrounds at least one of the terminals (H), its connecting wires, and its plates except for the field that produces the desired direct capacitance to the other terminal (L). Changes in the environment and the connections can vary the terminal capacitances,  $C_{HG}$  and  $C_{LG}$ , but the direct capacitance  $C_{HL}$  – usually referred to simply as the *capacitance* of the three-terminal capacitor – is determined only by the internal structure.

This direct capacitance can be calibrated by 3-terminal measurement methods, utilizing guard circuits or transformer-ratio-arm bridges, which exclude the terminal capacitances.

The direct capacitance can be made as small as desired, since the shield between terminals can be complete except for a suitably small aperture. The losses in the direct capacitance can also be made very low because dielectric losses in the insulating materials can be made a part of the terminal impedances. When the 3-terminal capacitor is reconnected as 2-terminal, the 2-terminal capacitance will exceed the calibrated 3-terminal value,  $C_{HL}$ , by the terminal capacitance  $C_{HG}$ .

**Two Terminals.** In the common 2-terminal connection, the capacitor has L and G terminals connected together, i.e., L terminal connected to case. The terminal capaci-

tance  $C_{LG}$  is thus shorted, and the total capacitance is the sum of  $C_{HL}$  and  $C_{HG}$ .

In general, since one component of the terminal capacitance  $C_{HG}$  is the capacitance between the terminal and surrounding objects, the total capacitance is changed by changes in the environment of the capacitor and particularly by the introduction of the wires required to make connection to the capacitor.

**NOTE**

There is a possible confusion between H and L. Usually the 2-terminal capacitor is labeled H for the more completely shielded connection, L for the one connected to shield (if any). However, the terminals of the 1616 bridge are labeled the opposite way: L for the inner, H for the outer part of the 2-terminal port. Bridge H connects to capacitor L and G, but G must not be grounded.

The uncertainties in the calibrated value of this 2-terminal capacitor can be of the order of tenths of a picofarad, if the geometry, not only of the capacitor proper but also of the environment and of the connections, is not carefully defined and specified. For capacitors of 100 pF and more, the capacitance can usually be adequately defined for an accuracy of a few hundredths percent, if the terminals and method of connection used for calibration are specified. For smaller capacitances or for higher accuracy, the non-coaxial 2-terminal capacitor is seldom practical. The 3-terminal arrangement is generally preferred. Nevertheless, there are very accurate capacitors (in all but the smallest sizes) with 2, coaxial, ungrounded terminals.

**Two Terminals, Coax Connection** (Figure 4-3). In the coaxial 2-terminal structure, capacitor terminal L is again connected to the case, but *not* ground. The case is a complete shield around the field that determines the direct capacitance  $C_{HL}$ . Fields outside the case contribute only to  $C_{LG}$ , which can be excluded from the measurement. So most environmental changes have little effect on accuracy.

If the bridge is designed to measure such a capacitor and each incorporates a suitable precision coaxial connector, the uncertainties of measurement can be as low as 100 attofarads. The realization of such precision depends largely on exacting definition of the boundary between capacitor and bridge. This boundary is represented in Figure 4-3 by line X-B. Physically, the boundary is the plane of the mating face of the outer conductor of the G900 connector, i.e., the reference plane of the connector. For precise measurements, the electric field must be entirely parallel to that reference plane so the portion represented by  $C_{x2}$  is unequivocally part of  $C_x$ , whereas  $C_{Fx}$  and  $C_o$  are not.

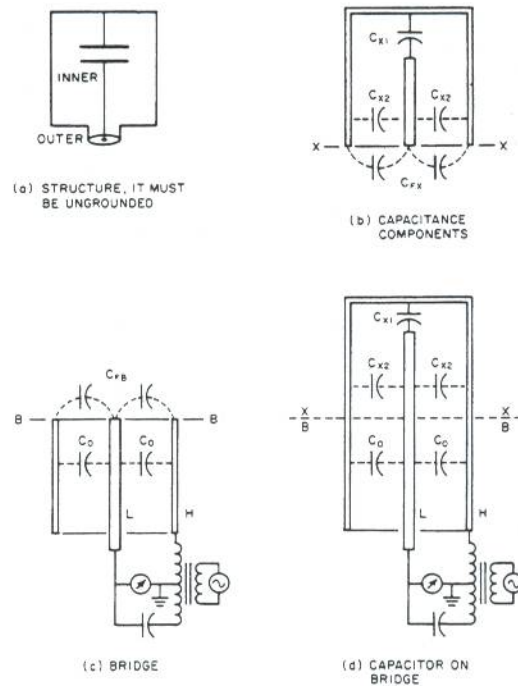

**Figure 4-3. A coaxial 2-terminal capacitor, its structure, component capacitances, and connection to a bridge.**

The fringing capacitance  $C_{Fx}$  makes the freestanding capacitance of the capacitor slightly greater than  $C_x$ . However,  $C_x$  is the value we always measure, calibrate, and refer to as the capacitance of the device.

The fringing capacitance  $C_{FB}$  makes the bridge terminal capacitance slightly greater when open-circuited than the value  $C_o$  which obtains when a suitable capacitor is attached. The ZERO ADJUST cannot be so accurately set with the UNKNOWN port open as with a standard coaxial 2-terminal capacitor installed. Limitations on the accuracy with which GenRad can specify  $C_{FB}$  involve uncertainty as to the position of spring-loaded parts in the G900 connector and reduced resolution because of "noise" picked up by the unshielded LOW terminal. However the repeatability is much better than the tolerance given  $C_{FB}$  in para. 3.4, i.e.,  $\pm 8$  fF.

**4.2.2 Inductive and Lossy Components. Figure 4-4.**

No physical capacitor is ideal, i.e., free of inductance and dissipation, although some are excellent. So also, the equivalent networks that are used to represent a nonideal capacitor do so imperfectly. However, they are satisfactory in many instances, particularly if some of the parameters are understood to be quasi-constants. (They may vary somewhat with temperature, humidity, pressure, frequency, acceleration, aging, illumination, etc.)

**Generalized Circuit.** Figure 4-4 (a) represents the non-ideal direct capacitance ( $C_{HL}$  of Figure 4-1) with 5 lumped

constants.  $R$  represents the metallic resistance in the leads, supports and plates;  $L$ , the series inductance of the leads and plates;  $C_1$ , the capacitance between the plates;  $C_K$ , the capacitance of the supporting structure. Conductance  $G$  represents the dielectric losses in the supporting insulators, the losses in the air or solid dielectric between capacitor plates, and the d-c leakage conductance. For most purposes,  $C_1$  and  $C_K$  are added as  $C$ . (Notice that  $C_K$  is zero if support-structure capacitance is entirely within  $C_{HG}$  and/or  $C_{LG}$ .)

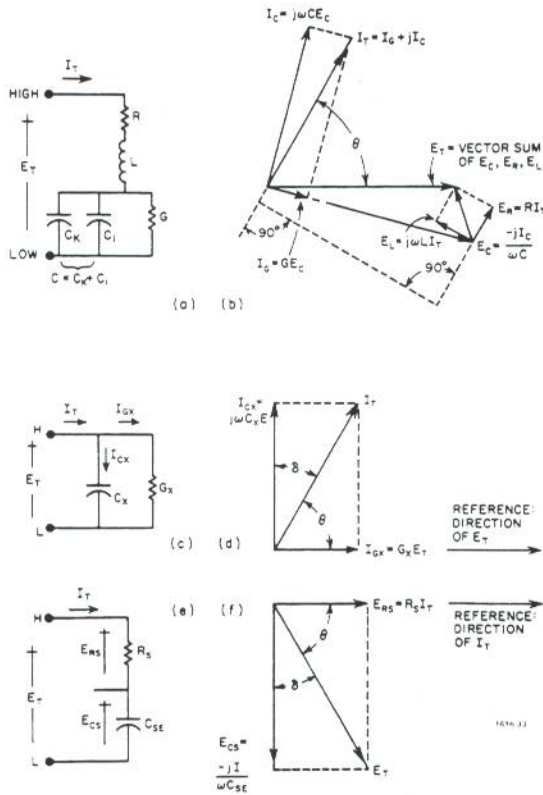

Figure 4-4. Capacitor lumped-parameter equivalent circuits and vector diagrams.

The corresponding vector diagram, Figure 4-4 (b) shows how the capacitive and conductive current components add to make  $I_T$ , and how the capacitive, inductive, and resistive voltage components add to form  $E_T$ .  $I_T$  leads  $E_T$  by the phase angle  $\theta$ , between  $0^\circ$  and  $90^\circ$ , as is characteristic of a physical capacitor. (We are not interested in conditions at such high frequency that  $I_T$  lags  $E_T$ .) The complement of  $\theta$  is  $\delta$ , the dielectric loss angle.

Notice that, regardless of the relative magnitudes of the other vectors, a small inductive component ( $|E_L| < |E_C|$ ) always makes  $|E_T| < |E_C|$ . In other words, the presence of series inductance makes a capacitor apparently increase in capacitance as frequency (or the inductance) increases.

The effect of series resistance on apparent capacitance is opposite, because  $E_R$  tends to make  $|E_T| > |E_C|$ . But the effect of shunt conductance  $G$  on apparent capacitance is mostly to accentuate the effect of  $R$ , if any, by causing

more lag in  $I_T$ . By itself,  $G$  has no effect on apparent capacitance because the bridge resolves them separately.

**Equivalent Parallel Circuit.** Figure 4-4 (c) is the equivalent circuit based on the 2 components measured directly by the bridge. Terminal properties ( $E_T, I_T, \theta$ ) are identical with diagrams a and b. Diagram d shows the vector relationships.

The algebraic relationships between these components and those of diagram a are given below, followed by simplifying approximations that are convenient for studying the effects of one parameter at a time. It is the capacitance  $C_x$  (not  $C_{SE}$ ) that we generally mean by the term "apparent capacitance".

$$C_x = \frac{C(1 - \omega^2 LC) - G^2 L}{(1 - \omega^2 LC + RG)^2 + (\omega GL + \omega RC)^2}$$

$$G_x = \frac{G(1 + RG) + \omega^2 RC^2}{(1 - \omega^2 LC + RG)^2 + (\omega GL + \omega RC)^2}$$

There is a resonance between  $L$  and  $C$  at a frequency  $f_0$ . We are concerned only with the condition  $f < f_0$  (and  $C_x$  is positive).

At sufficiently low frequency ( $f \ll f_0$ ), we observe that  $\omega^2 LC \ll 1$ , but various losses may still make  $C_x \neq C$ , thus:

$$C_x \approx \frac{C - G^2 L}{(1 + RG)^2 + (\omega GL + \omega RC)^2} \approx \frac{C - G^2 L}{(1 + RG)^2}$$

$$G_x \approx \frac{G(1 + RG) + \omega^2 RC^2}{(1 + RG)^2 + (\omega GL + \omega RC)^2} \approx \frac{G}{1 + RG}$$

where the fractions at the right are valid at sufficiently low values of  $R$  and  $L$ .

If, however, we relax the frequency restriction to  $f < f_0$  but consider the case of negligible series loss ( $\omega RC \ll 1$ ) and reasonably small shunt loss ( $G < \omega C$ ), then  $C_x$  increases with a term proportional to  $f^2$  as follows.

$$C_x \approx C(1 + \omega^2 LC) = C \left[ 1 + \left( \frac{f}{f_0} \right)^2 \right]$$

With this information, the capacitance at, for example, a frequency of 2 MHz can be computed with high accuracy from the calibrated value at 1 kHz. For  $f/f_0$  up to 0.3 or so, the accuracy may be greater than that of a measurement at 2 MHz because of the difficulties in determining the measurement errors produced by residuals in the connecting leads outside the capacitor (unless, of course, one uses a bridge particularly designed for measurement at 2 MHz). You may use a grid-dip meter for measuring  $f_0$ , with the capacitor terminals shorted.

There are secondary effects on the apparent value of capacitance in a 3-terminal measurement that will not be described here except to say that they involve resonances among L and C components in all 3 basic parts of the network of Figure 4-1. (The series inductor in Figure 4-4 (a) may represent, at least in part, a wire carrying current not only to  $C_{HL}$  but also to  $C_{HG}$  or part of it.) These effects are generally negligible if the following approximation is valid within the desired measurement accuracy:

$$C \approx C \left[ 1 + \left( \frac{f}{f'_0} \right)^2 \right]$$

where  $f'_0$  is the lowest resonant frequency of the network. Estimate  $f'_0$  as the free ringing frequency of the largest C component, such as  $C_{HG}$ , (given some initial energy) with the capacitor-lead and cable inductances; assume the bridge HIGH terminal is virtually grounded and its LOW terminal is an open circuit.

**Equivalent Series Circuit.** Figures 4-4 (e) and 4-4 (f) present another 2-component equivalent circuit which may be appropriate if R and C are the only significant components of diagram a. However, the 1616 bridge does not measure  $R_s$  directly. In terms of the parallel equivalent circuit:

$$C_{SE} = C_x \left[ 1 + \left( \frac{G_x}{\omega C_x} \right)^2 \right]$$

$$R_s = \frac{G_x}{G_x^2 + \omega^2 C_x^2}$$

**Loss Factors.** An important characteristic of a dielectric material, and hence of the capacitor made from it, is the ratio of energy dissipated to energy stored, per cycle of ac. There are 3 commonly used "factors" to express the same characteristic.

1. Dissipation factor or loss tangent D is the ratio as defined above:

$$D = \cot \theta = \frac{G_x}{\omega C_x} = \frac{I_{Gx}}{I_{Cx}} = R_s \omega C_{SE} = \tan \delta.$$

Expressed in terms of the components of Figure 4-4 a:

$$D = \frac{G(1+RG) + \omega^2 RC^2}{\omega C(1 - \omega^2 LC) - \omega G^2 L}$$

If frequency is well below resonance and if both series and shunt losses are small, a good approximation is:

$$D \approx \frac{G}{\omega C} + R\omega C.$$

2. Storage factor or quality factor Q is the ratio of energy stored to energy dissipated per cycle of ac:

$$Q = \tan \theta = \frac{\omega C_x}{G_x} = \frac{E_{Cs}}{E_{Rs}} = \frac{1}{R_s \omega C_{SE}} = \frac{1}{D}$$

3. Power factor is the ratio of the real power (watts of dissipation) to the product of rms voltage and current (voltamperes):

$$P.F. = \cos \theta = \frac{I_{Gx}}{I_T} = \frac{E_{Rs}}{E_T} = \sin \delta.$$

Notice that several other convenient expressions can be taken from Figure 4-4, such as Q or D in terms of current components in diagrams c and d or voltage components in diagrams e and f. Other convenient expressions are given in para. 3.6, for use of D or Q in converting data from series-equivalent to parallel-equivalent circuit forms and vice versa.

#### NOTE

For low-loss capacitors, the difference between D and P.F. is very small. For  $D = 10^{-1}$ ,  $10^{-2}$ , and  $10^{-3}$ ;  $(D - P.F.)/D$  is 0.5%, .005%, and  $5 \times 10^{-5}\%$ , respectively.

#### 4.2.3 Frequency Characteristics.

The lumped-parameter equivalent circuit such as Figure 4-4, a, for a real, physical capacitor is most appropriate under the conditions in which the parameters (R, L, C, G) are constants. In the following examples are some situations in which they are, others in which we have to treat them as quasi-constants, or develop special "constants".

**Capacitance.** At high frequencies, the inductive effect predominates ( $C_x$  increases with  $f^2$ ). At low frequencies,  $C_x$  is essentially constant if Q is very high and the dielectric is air. But if the capacitor has a solid dielectric, such as mica, it is responsible for a slight capacitance change with frequency;  $C_1$  is then a quasi-constant.

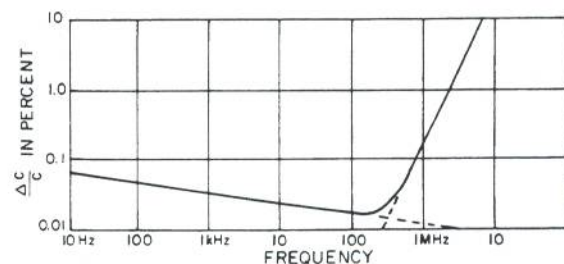

Figure 4-5. Capacitance vs frequency characteristic of a mica capacitor.

The change in capacitance  $C_x$  with frequency, of a 1000-pF capacitor with mica dielectric, is shown in Figure 4-5. The dashed line slanting downward to the right represents the change in the dielectric constant of mica resulting from interfacial polarization; that slanting upward to the



right shows the change in effective capacitance  $C_x$  resulting from series inductance. Though the former phenomenon may be true at much higher frequency, it can be neglected above 300 kHz in this example, because there the latter effect is so predominant. The magnitude of the change at low frequencies depends upon the dielectric material and is, for example, much smaller for polystyrene than for mica.

**Dissipation Factor.** At high frequencies, "series" loss predominates because of skin effect in the leads and plates (as explained below). At low frequencies, "shunt" loss predominates, but  $G$  may be far from constant. If good-quality, low-loss, solid dielectrics are used,  $G$  is nearly proportional to  $\omega$ ; then it may be useful to treat  $G/\omega C$  as the quasi-constant  $D_1$ .

The skin effect can be represented by considering  $R$  a variable,  $R = R_1 \sqrt{\omega}$ , in the second term,  $R\omega C$ , of the formula for  $D$ , then:

$$D = D_1 + R_1 C \omega^{2/3}$$

The dissipation factor as a function of frequency for a mica capacitor is shown in Figure 4-6. There  $D$  is the sum

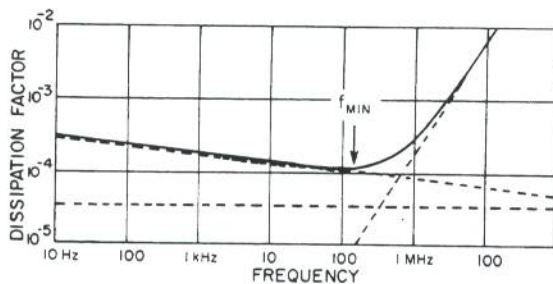

Figure 4-6. Dissipation factor vs frequency characteristic of a mica capacitor.

of three principal components: a constant dissipation factor caused by residual polarizations and shown by the horizontal dashed line; a loss produced by interfacial polarizations, which contributes the  $D$  shown by the dashed line slanting downward to the right; and an ohmic loss with skin effect in the leads and plates, which results in a  $D$  proportional to the 3/2 power of frequency and is shown as the dashed line slanting upward to the right. The total dissipation factor has a minimum value at a frequency that depends on the size of the capacitor;  $f_{MIN}$  varies inversely with capacitance and ranges from 1 kHz to 1 MHz for capacitance values from 1  $\mu$ F to 100 pF.

In an air capacitor, the losses in the air dielectric and on the plate surfaces are negligible under conditions of moderate humidity and temperature. The loss is, therefore, largely in the insulating supports, and the above formula applies. However, if the capacitor is variable, and the varying part is lossless,  $D_1$  varies inversely with  $C$ . Then it is preferable to treat  $G/\omega C$  as  $G_1/\omega C$ , where  $G_1$  is the

effective conductance at  $\omega = 1$ . Thus, for the variable air capacitor:

$$D = \frac{G_1}{C} + R_1 C \omega^{2/3}$$

At very low frequencies, a "shunt" loss conveniently represented by  $G$  may be significant. Leakage conductance  $G$  is usually negligible at frequencies above a few Hz and is important only when the capacitor is used at dc for charge storage. The dominant components of  $D$  at audio frequencies are the dielectric losses in the insulating structure and in the dielectric material between the plates.

### 4.3 BASIC BRIDGE CIRCUITRY.\*

#### 4.3.1 Elementary Capacitance Bridges.

Measurements of capacitance, particularly those of high accuracy, are made by a null method that uses some form of the basic ratio bridge, shown in Figure 4-7. The capaci-

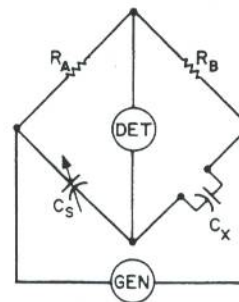

Figure 4-7. An elementary capacitance measuring bridge.

tance of the unknown,  $C_x$ , is balanced by a calibrated, variable, standard capacitor,  $C_s$ , or by a fixed standard capacitor and a variable ratio arm, such as  $R_A$ . Such bridges with resistive ratio arms and with calibrated variable capacitors or resistors can be used over a wide range of both capacitance and frequency and with a direct-reading accuracy which seldom exceeds 0.1%.

For higher accuracy, resolution, and stability in capacitance measurements at audio frequencies, a bridge with inductively-coupled or transformer ratio arms has many advantages, and increasing use of transformer-ratio-arm bridges is being made in the measurement of many types and sizes of capacitors.

#### 4.3.2 Transformer-Ratio Bridges.

The advantages of transformer ratio arms in a bridge are that accuracies within a few parts per million are not difficult to obtain over a wide range of integral values, even for ratios as high as 1000 to 1, and that these ratios are almost unaffected by age, temperature, or voltage. The low impedance of the transformer ratio arm also makes it easy to measure direct impedances and to exclude the ground

\*Thomas, H. E., and Clarke, C. A., *Handbook of Electronic Instruments and Measurement Techniques*, Prentice-Hall, Englewood Cliffs, N. J. (1967) p 36-57.

impedances in a three-terminal measurement without the use of guard circuits and auxiliary balances.

To illustrate these characteristics, a simple capacitance bridge with transformer ratio arms is shown in Figure 4-8. On the toroidal core, a primary winding, connected to the generator, serves only to excite the core; the number of primary turns,  $N_p$ , determines the load on the generator but does not influence the bridge network. If all the magnetic flux is confined to the core — as it is to a high degree in a symmetrically wound toroid with a high-permeability core — the ratio of the open-circuit voltages induced in the two secondary windings must be exactly equal to the ratio of the number of turns. The ratio can be changed by the use of taps along the two secondaries, but, when the ratio is fixed, the voltage is highly invariant. Changes in the core permeability with time and temperature have only very small effects on the effective ratio. It depends not only on the turns ratio (a perfect integer) but also on leakage flux, which is not confined to the core in a practical transformer. The ratio is, therefore, both highly accurate and highly stable.

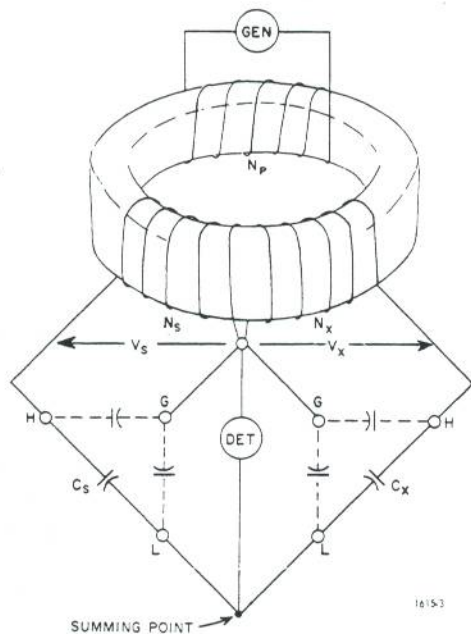

Figure 4-8. An elementary capacitance bridge with transformer ratio arms.

In Figure 4-8, the two transformer secondary windings are used as the ratio arms of the capacitance bridge with the standard capacitor,  $C_s$ , and the unknown,  $C_x$ , as the other two arms in a conventional four-arm bridge network. The condition for balance, or zero detector current, is easily shown to be that

$$V_s C_s = V_x C_x, \text{ therefore: } \frac{C_x}{C_s} = \frac{V_s}{V_x} = \frac{N_s}{N_x}$$

This balance condition is not affected by the capacitances shown from the H and L terminals of  $C_s$  and  $C_x$  to

the terminal G connected to the junction of the ratio arms. The capacitances between L and G shunt the detector, so that they affect only the bridge sensitivity. The capacitances between H and G are across the transformer windings. To the extent that the transformer can be assumed ideal, i.e., with no resistance in the secondary windings and with no flux that does not link equally both secondaries, the current drawn by the H-G capacitances does not change the voltages  $V_s$  and  $V_x$  or the balance conditions. In practice, the transformer resistances and leakage inductances can be kept so small that quite low impedances or large capacitances can be connected from H to G before there is appreciable error in the bridge.

The junction of the ratio arms, G, is therefore a guard point, or guard potential, in the bridge. All capacitances to G from the H or L corners of the bridge are excluded from the measurement. In the three-terminal capacitors represented by the H, L, G terminals in Figure 4-8, the bridge measures only the direct capacitance,  $C_x$ , of the unknown in terms of the direct capacitance,  $C_s$ , of a standard without additional guard circuits or balances.

One can take advantage of the accurate and stable ratios of the transformer by designing a bridge with an "unknown" arm that is fixed and a ratio that can be varied to balance the bridge. Far greater measurement accuracy is feasible with such a design approach (making  $C_s$  a fixed capacitor rather than a variable one). For example, consider the following alternatives.

Figure 4-9 shows three of the possible ways of balancing a simple transformer-ratio capacitance bridge. For simplicity, the generator and primary are not shown, but it is assumed that the two secondaries have 100 turns each and are excited so that there is 1 volt per turn. The capacitor in the unknown arm is assumed to be 72 pF.

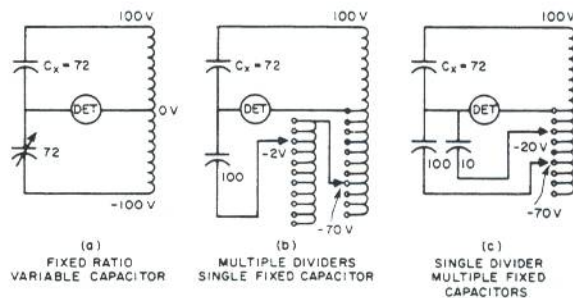

Figure 4-9. Circuitry for 3 methods of balancing a transformer-ratio capacitance bridge.

In Figure 4-9a, the two ratio arms are equal and the bridge is balanced in the conventional way with a variable standard capacitor which is adjusted to 72 pF.

The detector current can equally well be adjusted by a variation in the voltage applied to a fixed standard capacitor. In Figure 4-9b, the standard capacitor is fixed at 100 pF. This is balanced against the 72-pF "unknown", connected to the 100-V end of the transformer, by connection of

the standard to 72 V of the opposite phase, obtained from suitable taps on the transformer windings. The inductive divider shown has a winding of 100 turns with taps every 10 turns and, on the same core, another winding of 10 turns tapped at every turn. If, as shown, the second winding is connected to the 70-V tap on the first winding and the capacitor to the 2-V tap on the second winding, the required 72 V is applied to the capacitor. Six or more decades for high precision can be obtained in a similar fashion with more windings on one core and the use of additional transformers driven from the first. Such inductive dividers have very accurate and stable ratios, but the errors increase with the number of decades because of loading effects.

Another method of balance by voltage variation is shown in Figure 4-9c, where a single decade divider is used in combination with multiple fixed capacitors. The 100-turn secondary is tapped every 10 turns to provide 10-V increments. If, then, a 100-pF capacitor is connected to the 70-V tap and a 10-pF capacitor to the 20-V tap, the resulting detector current balances that of the 72-pF "unknown", connected to 100 volts. This bridge can be given 6-figure resolution, for example, through the use of 6 fixed capacitors in decade steps from 100 pF to 0.001 pF, each of which can be connected to any one of the taps on the transformer.

In any of these bridges, the bridge ratio can also be altered by use of taps on the "unknown" side of the transformer to select the voltage applied to the capacitor being measured. For example, a 720-pF capacitor would be balanced in any of the circuits of Figure 4-9 if connected to a 10-turn (10-V) tap on the upper winding. The range of the bridge can thus be extended to measure capacitors which are much larger than the standards in the bridge.

These advantages of transformer ratio arms and dividers make possible a bridge of wide capacitance range, and high accuracy, one that is useful over a wide frequency range. It is economically reasonable to construct the relatively few, fixed capacitance standards to have the necessary stability and accuracy for such a bridge, one that will measure with .01% accuracy over 6 decades of capacitance and 3 decades of frequency. At low frequencies, a limit is imposed on sensitivity by the maximum voltage obtainable from the transformer, since, for a given core, the voltage at saturation is proportional to frequency. At high frequencies there is a decrease in accuracy resulting from the decrease in core permeability with frequency, from the increased loading of the transformer by its self-capacitance as well as the bridge capacitances and, of course, from the usual residual capacitances and inductances in the bridge wiring and components.

#### 4.4 CIRCUITRY OF THE 1616 BRIDGE. **Figure 3-3.**

In general, this capacitance bridge is based on the 3rd method, Figure 4-9, c. Each of the 12 internal capacitance

standards is calibrated at a cardinal value and each is switched to an appropriate tap on the ratio transformer as you bring the bridge to balance. Conductance (or loss in the capacitor being measured) is balanced by the same method. Conductance standards of fixed, cardinal values are switched to appropriate taps on the same ratio transformer. The circuitry is described in more detail in the following paragraphs.

##### 4.4.1 Excitation.

The application of sufficient voltage (power is mostly reactive) from the oscillator to the ratio transformer provides a test signal so the detector will respond to an unbalance. The level of excitation is limited, always below the saturation level of the transformer core. The primary winding of 200 turns is driven directly by the oscillator POWER OUTPUT port. Several design features eliminate stray coupling to other parts of the bridge and particularly to the detector.

1. The GENERATOR INPUT port is connected to the transformer by a shielded wire.
2. This shield is floating in the bridge (grounded only at the oscillator).
3. In the ratio transformer, the primary winding is surrounded by an electric shield that is grounded in the bridge.

##### 4.4.2 Circuit for the Unknown. **Figure 3-1, 3-2.**

The 2 terminals of  $C_x$ , HIGH and LOW, must be connected, respectively, to the ratio-transformer secondary (upper half, in the simplified diagrams) and the summing point (which drives the detector). Because the midpoint of the ratio-transformer secondary winding is grounded, both terminals of  $C_x$  must be floating. However, the 3rd terminal or shield of the capacitor under test is grounded at the 3-terminal port.

The facility for measuring capacitors larger than the largest standard, as mentioned above, obtains when the TERMINAL SELECTOR switch points to X10 or X100. Then, the HIGH side of  $C_x$  is connected to the 20- or 2-turn tap, respectively, of the secondary winding. When the selector indicates X1, the connection is to the 200th turn from ground. Then the voltage across the unknown capacitor at balance equals the oscillator voltage.

Each of the UNKNOWN terminals is disconnected from the bridge and grounded whenever the TERMINAL SELECTOR selects CAL. When it selects 3-TERMINAL, the 2-terminal port is likewise grounded, and vice versa.

##### 4.4.3 Capacitance Standards. **Figure 3-3.**

There are 12 capacitance standards, one for each multiple of 10 from 100 nF down to an effective value of 1 aF. The "high" side of each is connected to the front-panel-selected tap on standards side of the transformer secondary

(generally the lower half in the simplified diagram). The "low" side of each standard is permanently connected to the same summing point, mentioned above, which drives the detector. However, the 2 largest C standards can be disconnected from the summing point by dropping the C MAX lever switch. Thus, stray capacitance shunting the detector can be reduced while you measure extremely small values of increments of  $C_x$ .

Each of the first 6 CAPACITANCE lever switches indicates values in *tenths* of the value of its associated standard. Thus, the lever with a - 1, 0, 1, 2, . . . 9, X -pF readout actually switches the 10-pF standard capacitor.

The maximum current through each of these standard capacitors (when the corresponding readout is X, i.e., ten) obtains when its HIGH side is connected to the transformer secondary at the 200th turn,  $180^\circ$  out of phase from the unknown-capacitor-X1 connection. That is the bottom of the transformer as shown in simplified diagrams. The intermediate taps are 20 turns apart. The zero position is a ground connection. The - 1 position is a connection to a 20-turn tap on the "unknown" side of the transformer secondary.

In order to provide greater stability in the set of capacitance standards it is preferable to use a moderate valued capacitor connected to fewer turns than an extremely small valued one connected to the usual number of turns. Therefore a set of taps is brought out from the ratio transformer at intervals of 2 turns (to a maximum of 20 turns). Each capacitor that connects to this set of taps is 10 times as large as it would have to be if it were connected to the usual (20-turn-per-step) taps. The last 6 "C" lever switches span 2 turns per step. The 6 associated standard capacitors are each 10 times as large as the effective values shown in Figure 3-3.

Therefore, each of the last 6 CAPACITANCE lever switches indicates values in *hundredths* of the value of its associated standard. Thus the lever with a - 1, 0, 1, 2, . . . 9, X -aF readout actually switches the 100-aF standard capacitor. For these, of course, the - 1 position is a connection to a 2-turn tap on the "unknown" side of the transformer.

Physically, the transformer is manufactured with a separate winding of 22 turns, tapped every 2 turns for the small C standards. A set of 20 windings of 20 turns each serves the large C standards and the "unknown", by a series combination that acts as a center-grounded 400-turn secondary. Except for the primary (200 turns) all these windings are very intimately coupled by multifilar construction.

Each C standard is calibrated to the desired value by means of a trimmer. All 12 are located behind the locked door in the front panel (Figure 1-2), where they are labeled with the effective values of the corresponding standards, as shown in Figure 3-3. Calibration procedures are given in Section 5.

#### 4.4.4 Conductance Standards.

Figure 3-3.

There are 5 conductance standards and a multiplier circuit for reducing their effective values in steps, so that you have virtually 11 conductance standards, one for each multiple of 10 from 10  $\mu$ S down to 1 fS.

Like the capacitance standards, the conductance standards connect as follows: high side, via lever switches, to taps on the standards side of the transformer; low side, via multiplier circuitry to the summing point that drives the detector.

Because this bridge is designed for the greatest precision in C rather than G measurements, it is preferable to have the main (20-turn-per-tap) secondary winding carry only C-standards currents. Therefore, the G standards are connected to the other (2-turn-per-step) winding described before. Consequently, each of the 5 conductance standards is 10 times as large as the effective values shown in Figure 3-3.

It follows that each of the 5 CONDUCTANCE lever switches indicates values in *hundredths* of the value of its associated standard. Thus the lever with a - 1, 0, 1, 2, . . . 9, X -  $\mu$ S readout actually switches a 100-  $\mu$ S standard of conductance, i.e., a precision 10-k $\Omega$  resistor.

When the G multiplier is set to X1, the connection from the set of 5 conductance standards to the detector is direct. When that setting is X  $10^{-1}$ , a resistor network passes only 10% of the conductance standards' current to the detector summing point. (The other 90% returns directly to ground). Similarly, at X  $10^{-2}$ , 1% passes to the summing point. The "box" (with these G standards and networks) also contains pots for setting the multiplier ratios exactly to the appropriate powers of 10: R18 for  $10^{-1}$ , R19 for  $10^{-2}$  etc. These pots are intended for calibration purposes as described in section 5.

Ideally, the current through each conductance standard should be perfectly in phase with the ratio-transformer voltage. However, the resistor is bound to have some end-to-end capacitance. For example, R1 has some stray C in parallel. Without compensation, the current through this stray C affects the bridge balance condition like increasing the value of the C standard.

The compensation is represented schematically by C23, connected between the midpoint of R1 and ground. Refer to Figure 5-9. Physically, C23 is formed by a threaded, spring-loaded sleeve surrounding the main part of R1 and adjustable by turning with a special wrench. The current component from the transformer through C23 leads by a large angle (nearly  $90^\circ$ ) causing the voltage at the midpoint of R1 to lag slightly with respect to the ratio-transformer voltage. If the compensation is adjusted correctly, the resulting lag in the current from the middle of R1 to the detector is just sufficient to cancel the leading current through the stray C.

Not only is each of the 5 G standards compensated in this way, but also 1 of the 4 series resistors in the G

multiplier network. Thus, R9 passes through a similar sleeve with capacitance represented as C22. There is, of course, more stray capacitance to ground in the G-standard circuit when the G multiplier is set to some multiple other than X1. Consequently, in some of the positions of that switch, the necessary compensation to achieve zero phase shift is the addition of capacitance shunting the series resistor. So, for example, for the  $10^{-1}$  multiplier, R6 has the adjustable C18 in parallel.

The desired result is complete independence of C and G balances, and hence measurements. A measure of the quality of the compensation is  $D_0$ , the ratio of conductance to 1-kHz parallel susceptance of  $C_c$  of the G standard  $G_s$ . (We refer to the effective conductance, including the multiplier network if it is involved, and the effective susceptance, including the compensation described above.) Refer to para. 3.9.3.

$$D_0 = \frac{G_s}{2\pi 10^3 C_c}$$

Because of the compensation described above,  $C_c$  is very small and can be negative. Thus, the factory adjustments assure that the magnitude of  $D_0$  is very large for any G-standard and G-multiplier combination you chose.

Because it is extremely difficult to obtain external standards of conductance with zero or known shunt capacitance, *we do not recommend any readjustment of the "C" compensation in the G box*, i.e., do not turn any of the sleeves; do not replace any resistor passing through a spring-loaded threaded sleeve in the G box. C18 and C20 . . . C27 are "factory adjustments".

#### 4.4.5 External Standards.

An external standard, or whatever you connect to that port, is connected like a capacitance standard (a large one). The LOW terminal is grounded, when EXT MULTIPLIER is set to OFF; and otherwise connected to the detector summing point. The HIGH terminal also connects to ground in the OFF position, as well as in the 0 position. HIGH connects to the ratio-transformer in steps of 20 turns. Unlike the CAPACITANCE lever switches, the EXT MULTIPLIER indicates *directly* the fraction you select of the external standard (in farads and Siemens). Thus, the settings of  $-.1, 0, .1, .2, \dots .9, 1.0$  indicate (respectively) that  $-0.1, 0, 0.1, 0.2, \dots 0.9, 1$  times the external-standard C and G are added to the CAPACITANCE and CONDUCTANCE indicated by the lever switches.

#### 4.4.6 Zero Adjust.

Figures 3-2, 6-3.

This front panel adjustment is primarily intended to compensate the bridge for a few pF of terminal capacitance when you chose a 2-terminal position of the TERMINAL SELECTOR switch. The adjustable component is the pot

R24, connected across 2 turns of the ratio transformer (on the standards side), with its wiper arm capacitively coupled through C17 to the detector summing point. Therefore, a capacitive balance can be made without moving the C lever switches and a "zero offset" can be chosen so that the readout is zero for some convenient reference condition in 2-terminal measurements. (See para. 3.4.2.)

A second function of the ZERO ADJUST control is to compensate the bridge for a few aF of variation in effective zero offset among the CAL, 3-TERMINAL X1, and X10 positions of the TERMINAL SELECTOR switch. (In the latter 2 positions, the 3-TERMINAL UNKNOWN LOW connector must be shielded with a Type 874-WN Open-Circuit Termination to remove the 125 aF or so of terminal capacitance from the bridge.) The circuit from R24 through C17, although it is now disconnected from the detector and grounded by the TERMINAL SELECTOR switch, nevertheless couples enough signal to the summing point for the purpose described before. (Notice that the range of adjustment is now reduced by a factor of  $10^6$  or so.) A coarse adjustment, C301, very lightly couples some signal of the opposite phase to the detector (via the G box) and is provided so you can make sure that the ZERO ADJUST control, somewhere in its range, reaches the desired zero condition for each of the first 3 positions of TERMINAL SELECTOR. (Each position will require a different ZERO ADJUST setting.)

The obvious utility of this second function is to make the CAPACITANCE readout true, down to the 12th digit, so you need not add a "zero correction" to each measurement. However, accuracy in that digit is insignificant for  $C_x$  above about 100 fF (0.1 pF). Therefore, only if you must measure such small capacitors will you need this function regularly. It does have utility in recalibration of the bridge, particularly in trimming the smallest internal C standards with the larger ones as references.

### 4.5 C-STANDARDS ACCURACY.

#### 4.5.1 Calibration.

The set of 12 internal capacitance standards can be calibrated quickly and accurately by a series of comparison balances starting with a single external standard capacitor of almost any size within the range of the bridge. Since the 8-figure resolution of the bridge permits comparison with a precision of 1 ppm down to 0.1 pF, the accuracy of calibration is usually determined by the accuracy of the standard.

Only one external standard is required, most conveniently a 3-terminal 100-pF standard, such as the GR Type 1404-B. With a test frequency of 1 kHz, the accurate, internal 0.1 transformer ratio can be used to ensure accurate decade ratios of the internal capacitance standards. The  $-1$  position of any capacitance balance switch connects the corresponding internal capacitor to a 20-turn tap on the "unknown" side of the ratio trans-

former. This capacitor can be compared with the next lower decade capacitor, which is connected to the 200-turn winding on the standard side when the corresponding lever is set to the X position. Any adjustments required can then be made with one of the trimmers accessible beneath a hinged cover on the front panel. Refer to para. 5.4.

Such checks or recalibrations of the bridge need not be made often. The capacitors are constructed to be so stable that after calibration they may be expected to change less than 10 ppm per year in normal use. The temperature coefficients of the internal standards are stated in the Specifications and the consequent effect of temperature on accuracy is summarized in para. 3.9.

#### 4.5.2 Sealing.

The "air-dielectric" standards, except the 4 smallest, are filled with dry nitrogen and sealed. If they were open to the atmosphere, their capacitance would change 20 ppm for each 10% change in humidity and about as much again for each 300 meters of elevation or 3% change in barometric pressure because of the weather. Sealing practically eliminates these influences.

The 2 largest capacitors, with selected mica dielectric, are also sealed to keep them dry and stable with respect to the effects of humidity.

#### 4.5.3 Thermal Lag.

The 8 largest internal capacitance standards are housed in a "lag box," a thermally insulated container that comprises most of the "C box," within the bridge. For the purpose of estimating transient temperature effects on precision of measurements, we represent the thermal properties of the lag box simply as follows:

1. The mass M inside the box is all at temperature  $\theta_i$ .
2. Heat is transferred through massless insulation of thermal resistance R.

Then the lag box will respond to a step change  $\Delta\theta_e$  in environmental temperature (from  $\theta_o$  to  $\theta$ ) at time zero with a simple, exponential change of internal temperature  $\theta_i$  as follows: (A close analogy exists to a series R-C circuit, capacitance being analogous to M, applied voltage to  $\theta$ , and the capacitor voltage to  $\theta_i$ . For the electrical circuit, the time constant is RC, for this thermal model, RM.)

$$\theta_i = \theta_o + \Delta\theta_e \left(1 - e^{-\frac{t}{RM}}\right)$$

where  $e$  is 2.718... and  $t$  is time (in the same units as RM).

Consider rate of change of inside temperature at any time  $t$ :

$$\frac{d}{dt} \theta_i = \frac{\Delta\theta_e}{RM} e^{-\frac{t}{RM}}$$

During any time interval  $\Delta t$ , that is very small compared to the time constant, the internal temperature change is that rate of change multiplied by  $\Delta t$ . The corresponding fractional C change for a capacitor with a temperature coefficient  $\alpha$  is therefore:

$$\frac{\Delta C}{C} = \alpha \Delta t \frac{\Delta\theta_e}{RM} e^{-\frac{t}{RM}} = \alpha \frac{\Delta t}{RM} (\Delta\theta_e) e^{-\frac{t}{RM}}$$

Example 1: what is the fractional change of the 3rd-decade internal capacitance standard during a 5-minute measuring process, if the environmental temperature is known to be maintained in the range  $23^\circ \pm 1^\circ\text{C}$ ? The worst possible case is  $\theta_o = 22^\circ\text{C}$  and  $\Delta\theta_e = 2^\circ\text{C}$ . From the specifications, a representative value for  $\alpha$  is 3 ppm/ $^\circ\text{C}$ ; the time constant for the lag box in the bridge is 360 minutes (6 hours). So:

$$\frac{\Delta C}{C} = \left(3 \frac{\text{ppm}}{^\circ\text{C}}\right) \left(\frac{5 \text{ min}}{360 \text{ min}}\right) (2^\circ\text{C}) e^0 = .083 \text{ ppm.}$$

Example 2: What is the effect of a change, 18 hours ago, from  $10^\circ$  to  $23^\circ\text{C}$ ?

$$\frac{\Delta C}{C} = \left(3 \frac{\text{ppm}}{^\circ\text{C}}\right) \left(\frac{5}{360}\right) (13^\circ\text{C}) e^{-3} = .027 \text{ ppm.}$$

#### 4.6 G-STANDARDS ACCURACY.

The basic conductance accuracy of 0.1% depends on precision resistors and multiplier networks that can be calibrated against external standards. The very high degree of independence between G and C balances depends on factory-set compensation in the G box, measured in terms of  $D_o$ , and the minute losses in the C standards, which are specified.

As indicated in the parts list, the greatest accuracy is provided in the standards for the first 2 positions of the G readout, R1 and R2. The next, R3, has a tolerance of  $\pm 0.1\%$ ; the following, R4 and R5, of  $\pm 1\%$ . Intercomparisons can easily be made using the bridge ratios, in a manner similar to the calibration of C standards. You can measure the error in R5, for example, (against R1 or R2) but no calibrating adjustment is provided.

Adjustments for the multiplier network are described in para. 5.4. Essentially, one makes the bridge balance with the correct G readout while a standard external conductance (or network) is connected to the UNKNOWN port.

The factory adjustments make  $D_o$  at least  $10^3$  for any G readout. This means, for example, if the unknown capacitor

has a Q of  $10^4$ , the 1-kHz error in C measurement due to stray capacitance in the G standards will not exceed 0.1 ppm. However, if the unknown *conductor* has a D of  $10^2$  at 1 kHz, the error in C measurement may be as much as 10%. Refer to para. 3.9 and 4.4. As a rule of thumb, at 1 kHz:

$$\frac{\delta C}{C} = \frac{1}{QD_0} = \frac{D}{D_0}$$

#### 4.7 RATIO ACCURACY.

To measure accurately with this bridge, you must properly balance a well defined unknown capacitor against accurate standards via accurately known ratios. Section 3 deals with system operation; 4.2, definition of the device being measured; and 4.5 accuracy of internal standards. The following paragraph deals with the accuracy of significant ratios in the bridge and their effect on your measurement.

The transformers in the Type 1616 Precision Capacitance Bridge are not quite the ideal transformers shown, for example, in Figures 1-1 and 3-3. The resistance, leakage inductance, and capacitances of the ratio-transformer windings, which are assumed to be zero in the simplified bridge theory, have been kept sufficiently small in the instrument so that errors from these residual impedances are less than 10 ppm for capacitances up to  $0.1 \mu\text{F}$  at a frequency of 1 kHz. However, the residual impedances make the voltages at the transformer terminals differ slightly from the voltages induced in the windings and produce bridge errors that increase with frequency and with the magnitude of the measured capacitance.

The accuracy of the ratios when the transformer is lightly loaded is better than 1 ppm for the unity ratio and is better than 3 ppm for the 0.1 ratio at 1000 Hz or lower frequencies. The winding self-capacitances act as a more significant load as frequency increases, so that the error in a 0.1 ratio increases to about 30 ppm at 10 kHz and to 0.5% at 100 kHz. The phase errors are, in general, somewhat larger than the magnitude errors of the ratios. At 1000 Hz, the phase error is probably within  $\pm 10 \mu$  radians, but the error increases in approximate proportion to ratio and to the square of frequency.

##### 4.7.1 Residual Impedances.

Figure 4-10.

The simplified bridge diagram of Figure 4-10 is similar to that of Figure 3-2 but shows, in the equivalent circuit of the transformer, winding resistances ( $r$ ), leakage inductances ( $\ell$ ), and winding capacitances ( $C_{GT}$ ) in both the standard and unknown ratio arms. The magnitudes of these residuals vary on the standard side as the lever switches are moved, and on the unknown side as the TERMINAL SELECTOR is reset. The resistance  $r$  and inductance  $\ell$  are approximately proportional to turns in the ratio transformer itself. However, because we include the series impedances of intimately associated wiring and switches,

that approximation is invalid for small numbers of turns.  $C_G$  represents stray ground capacitance that is not associated with the transformer, but appears in parallel with  $C_{GT}$  at any given setting of the switches. Typical parameters are given in Table 4-1.

These residual impedances make the voltage  $V$  applied to the capacitor  $C_s$  or  $C_x$  differ from the voltage  $E$  induced in the transformer winding. For small residuals, the relationship between these voltages is:

$$\frac{V}{E} = 1 + \omega^2 \ell C_T - j\omega r C_T,$$

where  $C_T = C + C_{GT} + C_G$ , and we use additional subscripts s or x to designate the standard or "unknown" arm of the bridge.

For convenience we postulate "effective" values  $C'$  of the main capacitor  $C$  in each arm (Figure 4-8).  $C'_s$  and  $C'_x$  are related by the simple balance condition of para. 4.3, i.e., they are inversely proportional to the turns ratio. From the circuit of Figure 4-10, for small residuals,

$$C' = C(1 + \omega^2 \ell C_T),$$

and subscripts x or s can be used as before. Residuals on the standard side make  $C'_s > C_s$  and your readout rather low; residuals on the "unknown" side make  $C'_x > C_x$  and your readout tends to be high. There is likely to be some cancellation of errors, particularly when the turns ratio is 1:1.

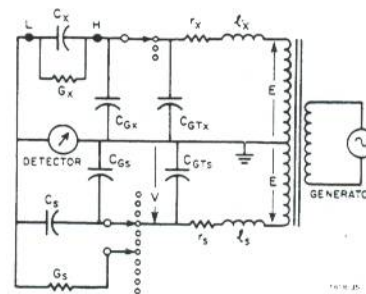

Figure 4-10. Simplified bridge schematic diagram showing residual impedances of the ratio transformer.

Table 4-1  
APPROXIMATE MAGNITUDES OF RESIDUAL PARAMETERS

Transformer turns	r	ℓ	C <sub>GT</sub>	Standard capacitor	C <sub>GS</sub>
2	.06 Ω	3 μH		100 nF	850 pF
6	.08	4		10 nF	500
20	.15	5		1 nF	150
60	.35	7		10 pF	75
200	1.05	10	300 pF	100 fF	100
Note: C <sub>GX</sub> ≤ 10 pF.				1 fF	35

The difficulty in determining the residual parameters for the many switch combinations makes impractical the detailed calculation of errors for correction of most measurements. However, the uncertainty or worst-case errors are presented in para. 3.9. Also, if the capacitance being measured is invariant with frequency, you can determine the error due to residuals for any given measurement with a few ancillary measurements and calculations. (Notice that the error term is proportional to frequency squared.) More convenient formulas are given below.

An effective conductance  $G'$  can be defined, analogous to  $C'$ .  $G'$  is larger than  $G$  by a term that is a hypothetical conductance adding a component of current to the detector summing point (under the ideal conditions of zero  $r$  and zero  $\ell$ ) equal to the true current component that flows through  $C$  *in phase* with  $E$  (because of  $r$ ). We assume the "unknown" is a capacitor; a slightly different analysis would be appropriate if it were a resistor.

$$G' = G + \omega^2 r C_T C$$

Subscripts  $x$  or  $s$  can be used, as before.

By definition of the primed symbols, they are related by the turns ratio. Usually, only the most significant standard is considered:

$$\frac{C'_x}{C'_s} = \frac{N_s}{N_x} = \frac{G'_x}{G'_s}$$

However, if more than one standard of similar significance is involved, the relationship is generalized as:

$$C'_x N_x = C'_{s1} N_{x1} + C'_{s2} N_{s2} \dots + C'_{sn} N_{sn}$$

An analogous formula can be used for  $G$ .

However, if we assume for simplicity that only one  $G$  standard is being used, we can express  $G_x$  and the  $G$  error, (readout -  $G_x$ ) in Siemens, thus:

$$G_x = \frac{N_s}{N_x} (G_s + \omega^2 r_s C_{T_s} C_s) - \omega^2 r_x C_{T_x} C_x$$

$$\Delta G = \omega^2 r_x C_{T_x} C_x - \frac{N_s}{N_x} \omega^2 r_s C_{T_s} C_s$$

Assuming, similarly, only one  $C$  standard is being used, we write the following expression for  $C_x$  and define a new effective capacitance standard  $C''_s$  which incorporates the

residual errors from both arms of the bridge. Assuming small residuals:

$$C_x = \frac{N_s C'_s}{N_x (1 + \omega^2 \ell_x C_{T_x})} = \frac{N_s C''_s}{N_x}$$

$$C''_s = C_s \left[ 1 + \omega^2 (\ell_s C_{T_s} - \ell_x C_{T_x}) \right]$$

The fractional  $C$  error is [the increment by which  $C_s$  differs from  $C''_s$ ]/ $C''_s$ ; for simplicity, we replace  $C''_s$  with  $C_s$  in the denominator:

$$C \text{ Error} = \frac{C_s - C''_s}{C_s} = \omega^2 (\ell_x C_{T_x} - \ell_s C_{T_s})$$

Notice that the coefficient of  $\omega^2$  can be determined experimentally, for any given  $C_x$  and switch settings for multipliers and most significant digits, by making 2 measurements at different frequencies; assume  $C''_s$  constant.

The effects of residual impedances on accuracy are summarized in 3 observations:

1. The effective value of the internal  $C$  standards is multiplied by  $(1 + kf^2)$  where  $k$  is constant as long as the ratio-transformer switches are not changed.
2. In general,  $k$  has either sign, and its magnitude is within the bounds indicated graphically in para. 3.9.
3. Because of the factor  $f^2$ , the residuals cause the predominant error at high frequency, above 10 kHz. Other errors predominate below 2 kHz.

#### 4.7.2 Example with 1:1 Ratio.

The errors in the bridge readings can be determined by the measurement of a calibrated capacitor. A convenient standard of capacitance and loss is a three-terminal air capacitor that can be connected directly to the bridge terminals to add a minimum of series inductance and resistance. For such a capacitor it can be assumed with good accuracy that the capacitance and loss have negligible changes with frequency up to 100 Hz and that any changes in bridge readings with frequency indicate bridge errors. Although the dissipation factor is not generally a simple function of frequency, in a clean air capacitor the magnitude should be sufficiently low, i.e., in the tens of ppm, that it can also be neglected.

The tabulated results were obtained when such a 1000-pF Capacitor was measured on a 1621 Capacitance-Measurement System; see Table 4-2.

Note that the apparent capacitance change at 100 kHz is only 200 ppm, as compared to the estimated standards-arm



**Table 4-2**  
ERROR EXAMPLE, RATIO 1:1

Frequency	C readout	Relative error	G readout
10 Hz	X00.500 pF	+7 ppm	0.035 S $\times 10^{-5}$
100	X00.495	+2	0.136 $10^{-2}$
1 kHz	X00.493	0	(-).240 $10^{-5}$
10	X00.488	-5	(-).884 $10^{-2}$
50	X00.385	-108	(-).608 $10^{-1}$
100	X00.164	-329	(-).7X0 1

error ( $\omega^2 \ell_s C_{T_s}$ ) of 5650 ppm. The smaller measured error results from a partial cancellation of transformer-impedance errors in the 2 ratio arms of the bridge. When, as in this example, the ratio is 1:1, the residual  $r$  and  $\ell$  are equal on both the standard and unknown sides of the transformer in Figure 4-10. If the total load,  $C_T$ , is also the same on both sides, the coefficient ( $\ell_s C_{T_s} - \ell_x C_{T_x}$ ) is zero and  $C_x = C''_s = C_s$  at any frequency.

In this example, and in general, the errors in the two bridge arms do not quite cancel because the total  $C_T$  on one side does not equal that on the other. The internal and external stray capacitances to ground,  $C_{G_s}$  and  $C_{G_x}$ , are seldom equal, since the bridge shields and wiring make  $C_{G_s}$  relatively high. Therefore, commonly,  $C''_s > C_s$  and the bridge readout is low. For example, other things being equal, if  $C_{G_s} - C_{G_x} = 100$  pF, the bridge would read low by 1600 ppm at 100 kHz.

This kind of error, being dependent on the internal ground capacitances, is altered by any rearrangement of decade switches to select alternative internal standards. In the following example, the same 1000-pF capacitor is measured with 2 of the several possible decade settings:

1 kc	100 kc
X00.498 pF	X00.163 pF
9X0.498	998.686

At 1 kHz, a setting of 9X was equivalent to X0, as it should be. At 100 kHz, not only was the measurement in error because of residual impedances, but the change from X0 to 9X resulted in a new balance requirement so the final readout was 99. In fact the two 100-kHz measurements differed from each other by considerably more than the original error due to frequency. The reading was lower for the second 100-kHz measurement than for the first, because the capacitance  $C_{G_s}$  was larger. With the X00 setting, the internal 1000-pF standard and its ground and wiring capacitance loaded the transformer predominantly; with the 998 setting, both the 100-pF and 10-pF standards were also connected and the ground capacitance was thereby increased about 170 pF. Also, several other capacitors were switched to higher taps in the final balance. This example is a very extreme case.

For a bridge ratio of 1:1, therefore, the bridge errors in C and G are typically less than, say, 1000 ppm at 100 Hz. Both errors are proportional to frequency squared. It is not usually practical to apply corrections for these errors to the bridge readings, chiefly because the magnitudes of the stray capacitances to ground and their variations with switch settings are not easily determined.

#### 4.7.3 The 10:1 Ratio.

Bridge errors from transformer residuals can, in theory, be reduced or eliminated by symmetry in the bridge circuit for any transformer ratio, just as in the example of the 1:1 ratio. All that is required is that  $\ell_x C_{T_x} = \ell_s C_{T_s}$  or  $\ell_x / \ell_s = C_{T_s} / C_{T_x}$  to make  $C_x = C_s$ ; hence, the residuals should be proportional to the ratio.

In practice, there are several reasons why the errors,  $\omega^2 \ell C_T$  or  $\omega^2 r C_T C_s$ , cannot be kept the same on both sides of the bridge as the ratio is increased. The residual impedances  $r$  and  $\ell$  (Table 4-1) differ slightly from proportionality to ratio, even when that is small. For high ratios, the  $r$  and  $\ell$  on the low side can never be less than the minimum values set by the wiring, switch, and terminal impedances. Any wires used to connect the unknown capacitor to the bridge also increase these residual impedances. The capacitance residuals also are seldom proportional to ratio. Although the bridge ratio is determined essentially by the ratio of the unknown and standard capacitances,  $C_x / C_s$ , the error depends upon total capacitance in the bridge arm, e.g.,  $C_T = C + C_{G_T} + C_G$ . Neither the transformer-winding capacitances,  $C_{G_T}$ , nor the ground capacitances of the capacitors,  $C_G$ , are proportional to ratio.

Generally, for a ratio of 10:1, the bridge errors in C may be as high as 0.3% at 100 kHz. The errors are dependent upon decade settings and stray capacitances in the bridge and also outside, so that corrections are not easily made.

#### 4.7.4 The 1:100 Ratio.

A typical situation in which you would use a 100:1 ratio is measuring a capacitor larger than 1  $\mu$ F. The large ratio generally means a large bridge error resulting from the residual impedances, but also simplicity in their effect and, therefore, a chance to correct your measurement by calculation.

Capacitance to ground from the UNKNOWN HIGH terminal, due to the capacitor attached there, can be measured (with another bridge) or estimated. That and  $C_{G_x}$  (Table 4-1) are usually negligible in determining the dominant factor  $C_{T_x}$  in the error.

$$C_{T_x} = C_x + C_{G_{T_x}} + C_{G_x} \approx C_x$$

$$\text{Error} = \omega^2 (\ell_x C_{T_x} - \ell_s C_{T_s}) \approx \omega^2 \ell_x C_x$$

Notice that this error is positive (readout is too high), that it is fractional (a dimensionless percentage, not a number of picofarads), and that it is proportional to frequency squared, the value of capacitor measured, and the total series inductance (including transformer leakage and those components of  $\ell_x$  in cables outside the bridge). Whether  $\ell_x$  includes also the series inductance within the structure of the unknown capacitor depends on definition. If not, then  $C_x$  is an effective "terminal" capacitance and is liable to be frequency dependent. If yes, then  $C_x$  is the series capacitance within that structure, and may be essentially independent of frequency.

The G error is more conveniently treated as an additive term (mhos) rather than a fractional error. Because of the sense of the large ratio and the limitations of resistance in switches and connections, the term containing  $r_x$  predominates, thus:

$$\Delta G = \omega^2 r_x C_{Tx} C_x - \frac{N_s}{N_x} \omega^2 r_s C_{Ts} C_s$$

$$\Delta G \approx \omega^2 r_x C_{Tx} C_x \approx \omega^2 r_x C_x^2$$

Again, this error is positive (readout is high). However, it is a number of Siemens, not a ratio. It is proportional to frequency squared,  $C_x^2$ , and to the total series resistance including those components of  $r_x$  in cables outside the bridge. Whether  $r_x$  includes any lossy component inside the capacitor under test depends on your definition. At any one frequency, the conductance can be expressed as an equivalent series component  $R_s$ , as shown in para. 3.6. Usually that is not included in  $r_x$ . However a known series resistance (often called "ohmic" resistance or d-c series resistance) may be treated as part of  $r_x$  and thereby excluded from your measurement.

As a rule of thumb, calculated corrections of the types given above (for C and G, for 1:100 ratio) are accurate to 5 or 10%. Use them to reduce the error of high-frequency measurement an order of magnitude; but if frequency is 30 kHz (for example) do not expect corrected measurements to be as accurate as 1-kHz measurements.

#### 4.7.5 C Offset Due to Induction.

In addition to the residual impedances previously

described, another source of error at high frequencies is the voltage induced in the internal bridge wiring connected to the detector circuit by currents flowing in the bridge circuits connected to the transformer. The bridge does not have the short, coaxial current paths required for radio frequency accuracy, and mutual inductances of the order of 0.1  $\mu$ H between bridge arms may be expected. Since the currents drawn from the transformer by the bridge capacitors increase with frequency ( $i = \omega CE$ ) and the voltages induced in the detector circuit are proportional to  $\omega Mi$ , these error voltages,  $e = \omega^2 MCE$ , increase with the square of frequency. The errors depend also, in a complicated way, upon the internal capacitors used, the transformer voltages applied to them, and therefore the front-panel switch settings. Experiments confirm, however, that these errors appear not as a percentage of the measured capacitance but as a more-or-less constant picofarad error or C offset at any one frequency. The order of magnitude of the error is 100 aF at 100 kHz.

#### 4.7.6 Ground-Circuit Impedance.

Another source of error, which may be significant when you measure a 3-terminal capacitor remotely at high frequency, is the finite impedance of the path between the shield of the capacitor and ground in the bridge. This path, usually through one or both shields of the cables connecting the capacitor to the 3-TERMINAL UNKNOWN port, has series R and L components  $Z_{sg} = R_{sg} + j\omega L_{sg}$  (Figure 3-1). Currents through ground capacitances  $C_{Is}$  and  $C_{Ic}$  return through  $Z_{sg}$ . The effects on the measurement are negative errors in both C and G; thus the correction is additive:

$$C_x = C_{\text{readout}} + \omega^2 C_{hs} C_{Is} L_{sg}$$

$$G_x = G_{\text{readout}} + \omega^2 C_{hs} C_{Is} R_{sg}$$

The error is most commonly noticed when  $G_{\text{readout}}$  is negative, both because it is often the larger of the two components and because negative loss in a capacitor is an obvious indication of the presence of error. An example is given in para. 3.9.

# Service and Diagrams – Section 5

5.1 GR FIELD SERVICE . . . . .	5-1
5.2 MINIMUM PERFORMANCE STANDARDS . . . . .	5-1
5.3 DISASSEMBLY . . . . .	5-1
5.4 RECALIBRATION AND ADJUSTMENTS . . . . .	5-7
5.5 TROUBLE ANALYSIS . . . . .	5-8
5.6 PARTS LISTS AND DIAGRAMS . . . . .	5-9
Exterior Views (Mech parts) . . . . .	5-11
Federal Manufacturing Code . . . . .	5-13
Figure 5-9. Schematic Diagram . . . . .	5-15
Appendix A . . . . .	A-1



## WARNING

Dangerous voltages may be present inside this case. These instructions are intended for the use of qualified service personnel only, to avoid electric shock, do not perform any servicing other than that contained in the operating instructions unless you are qualified to do so.

### 5.1 GR FIELD SERVICE.

Our warranty (at the front of this manual) attests the quality of materials and workmanship in our products. When difficulties do occur, our service engineers are available for technical telephone assistance. If the difficulty cannot be eliminated by use of the following service instructions, contact the GenRad Service Department in Concord, MA, giving full information of the trouble and of steps taken to remedy it. Describe the instrument by type serial, and ID numbers. (Refer to front and rear panels.)

**Instrument Return.** When returning an instrument to GenRad for service, please identify the failure mode as accurately as possible and include this information with the instrument. For instruments not covered by the warranty, a purchase order should be forwarded to avoid unnecessary delay.

For return shipment, please use packaging that is adequate to protect the instrument from damage, i.e., equivalent to the original packaging. Advice may be obtained from the GenRad Service Department in Concord, MA.

### 5.2 MINIMUM PERFORMANCE STANDARDS.

#### 5.2.1 General.

The equipment, methods, and criteria for verifying the specified performance of the 1616 Precision Capacitance Bridge in the 1621 Precision Capacitance-Measurement System are given below. Recalibration is described in para. 5.4. If performance is grossly inadequate, erratic, or cannot be corrected by the adjustments, refer to trouble analysis, para. 5.5.

Equipment needed for the measurements and procedures of this section is listed in Table 5-1. For all these proce-

dures, except as noted, set the front-panel controls initially to the standard positions, as follows:

#### *Oscillator* (1316).

- POWER – on (after preliminaries, para. 3.1).
- FREQUENCY – 1.01 kHz
- OUTPUT VOLTAGE RANGE – 15 V
- OUTPUT ADJUST – 10 on lower scale of meter

#### *Detector* (1238).

- POWER – ON (after preliminaries, para. 3.1)
- FREQUENCY – 1.01 kHz
- TIME CONSTANT – 0.3 s
- FINE ADJUST – each control at midrange
- PHASE SHIFT – 180° (Large dial at 0°)
- SENSITIVITY – maximum (cw)
- GAIN – 40 dB
- COMPRESSION – disabled (button out)
- LINE REJECTION – disabled (button out)

#### *Bridge* (1616).

- C MAX – down (3 windows closed)
- CAPACITANCE – zero
- CONDUCTANCE – zero
- Conductance Multiplier –  $\times 10^6$
- EXT MULTIPLIER – OFF
- TERMINAL SELECTOR – CAL
- ZERO ADJUST – any position

#### 5.2.2 Zero Setting, Offsets, and Sensitivity.

Verify that the capacitance offset  $C_0$  can be set to zero and measure the conductance offset  $G_0$ , as follows. Sensitivity and precision are also verified.

- a. Perform the preliminary and functional checks, tuning, and phase adjustments of para. 3.1-3.3.
- b. Install an open-circuit shield (Table 5-1) on the

**Table 5-1**  
**TEST EQUIPMENT**

Item	Requirements
Reference standard capacitor, (GR1404A)	Stability: 20 ppm/year; temperature coefficient: 2 ppm/°C; terminals: 3; value: 100 pF ±10 ppm.
Standard resistor, 100 kΩ	Accuracy, : ±.01% at 23° C.
Precision metal-film resistors	10 MΩ ±0.1% . . . . . 1 MΩ ±0.1% (4 required) . . . . . 10.2 kΩ ±0.1% . . . . . 100 Ω ±0.1% . . . . .
DC Resistance bridge (GR1666)	Basic accuracy: ±0.01%, direct reading; range 1 μS to 1 TΩ; 6-digit resolution.
Binding-post adaptor	Fits 2-TERMINAL UNKNOWN port (G900 connector), to BANANA JACK 3/4" spacing
Patch cords	Doubly shielded coaxial cable with locking G874 connectors; length: 3 ft. (2 required)
Open circuit	Shielded mount for conductance network; G874 connectors; (2 required).
Mount	Shielded mount for conductance network; G874 connectors; (2 required).

**Table 5-2**  
**CAPACITANCE RATIO CHECKS**

TERMINAL SELECTOR	nF	pF	fF	aF	Tolerance	Approx GAIN	Trimmer Label
3-ter x1	**	X00	see 5.2.3c	000	see 5.2.3d	70db	1nf
CAL	**	NX0	000	000.0	500aF	90	100pF
CAL	**	*NX	000	000.0	50aF	110	10pF
CAL	**	*0N	X00	000.0	10aF	120	1pF
CAL	**	*00	NX0	000.0	5aF	130	100fF
CAL	**	*00	0NX	000.0	5aF	130	10aF
CAL	**	*00	000	X00.0	50aF	130	1aF
CAL	**	*00	000	NX0.0	5aF	130	100aF
CAL	**	*00	000	0NX.0	5aF	130	10aF
CAL	**	*00	000	00n.X	2aF	130	1aF
CAL	*N	X00	000	000.0	5fF	50	10nF
CAL	NX	000	000	000.0	50fF	30	100nF

3-TERMINAL LOW connector. Set the TERMINAL SELECTOR to 3-TERMINAL X 10.

c. Balance the bridge precisely, with increased GAIN and (necessary) voltage, as described in para. 3.5, using the lever switches for G but only the ZERO ADJUST control for C. Leave the C readout at zero, except for temporary changes of a step or two in the last digit to test whether you have sufficient sensitivity for 9-figure resolution. Record the G readout as  $G_0$ , the conductance offset. It should not exceed  $.02 \times 10^{-6} \mu S$  in magnitude, and may be either + or -

d. Sensitivity is normally sufficient so that an oscillator voltage of 100 V, GAIN setting of 130 dB, and SENSITIVITY set near midrange result in a deflection of 25 (5 divisions) for 5 steps of the last C lever switch, near balance.

e. Repeat step c with the Terminal SELECTOR set to each of its 6 positions, the final one being 3 TERMINAL X1. The bridge is now set for  $C_0 = 0 \pm 0.1 \text{ aF}$ , on 3-TERMINAL X1, and  $G_0 =$  a known offset.

Note that the sensitivity of ZERO ADJUST is variable. Its setting is significant in 2-terminal measurements, but 3-terminal measurements can be made to specified accuracy without regard for how this control is set. A rear-panel, screwdriver adjustment is required if the range of ZERO ADJUST is inadequate for balance in step e.

### 5.2.3 Capacitance Accuracy.

Verify that the absolute value of one of the prime internal standard capacitors has been trimmed within specification, as follows.

#### NOTE

If the required external standard is unavailable, it is still possible to make a calibration verification with high confidence by making only the Capacitance Ratio Checks of paragraph 5.2.4. The internal standards are all of high stability so that checking all their ratios will almost always detect any excessive errors. The chance of all the standards changing by the same amount (in %) is very small.

a. Stabilize the temperature of the bridge at  $23^\circ \pm 1^\circ C$  for 24 hours previous to and during the following steps of para. 5.2.3 (36 hours is required after the bridge has been above  $45^\circ$  or below  $0^\circ C$ ; refer to para. 4.6).

b. Remove any shields from the 3-TERMINAL UNKNOWN terminals and connect instead an external reference standard with a nominal value of 1000pF known to an accuracy of 100ppm or better. (Note: the following instructions pertain in detail to the use of a 1000pF standard but a 10 or 100pF standard may be used if the calibration principle is understood.

#### NOTE

The accuracy of a suitable standard depends on the certified accuracy when calibrated by NBS or a standards laboratory, its stability and the time elapsed since calibration, its temperature coefficient and the temperature, etc.

c. Set the readout to the exact value of the 1000pF standard, starting with an X. For example, if the value is 1000.016pF, set X00.016pF. If the value is 999.989, set X00.N89 where N is -1. Set first row of Table 5-2.

d. Verify that the final C readout is not more than 10 ppm different from the *absolute* 3-terminal value of the C standard. If that is known to  $\pm 12$  ppm, for example, the acceptable tolerance on this measurement is  $\pm 22$  ppm, if  $\pm 3$ , then  $\pm 13$ .

e. Remove the external standard.

### 5.2.4 Capacitance Ratios.

The following procedure checks each internal standard against the next higher, or lower, standard starting with the 100pF standard being checked against the just-calibrated 1000pF standard as indicated in the 2nd row of Table 5-2. This and the next eight checks work down to the lowest standard. The last two checks work up from 1000pF to .1uF. (If a 100pF or a 10pF standard was used as the external standard, then this ratio procedure would start further down on this table and checks should be added that go up from the value of the standard used to values skipped.) The procedure for checking all other standards against the internal 1000pF standard is as follows.

a. Set the TERMINAL SELECTOR to CAL. Be sure EXT MULTIPLIER is set to OFF. Set C readout to all Zeros with first three digits masked using the C-MAX switch.

b. Balance the bridge with ZERO ADJUST and the G levers. Use the lowest G multiplier (10-6). Get negative G values using a -1 setting of the smallest digit possible. Leave the ZERO ADJUST as set. You now have  $C_0 < 0.1 \text{ aF}$  for bridge configuration set.

c. Set up each of the C-readout combinations starting with the second row of Table 5-2. For each, balance the bridge using the smaller C lever switches and the G controls as required. Verify that each balance is achieved within the tolerance limits indicated. Here \* indicates a zero digit covered by a mask as set with the C-MAX lever and N indicates a setting of -1.

If the detector phase adjustments are made as suggested by the Condensed Operating Instructions, the IN-PHASE meter may be zeroed with the C levers and a precise G balance is not necessary. This meter can also be used to extrapolate between C lever steps to estimate the error. The GAIN settings in the table are suggested as initial settings, more gain may be required.

### 5.2.5 Conductance Accuracy.

The following procedure makes use of 2 external standards to check the 5 basic internal G standards. (An equally valid check could be made by measuring each with a d-c bridge, a procedure which would require some disassembly and unplugging of connections to the "G box.")



#### CAUTION

Restrict the oscillator level to 20 V rms or less when the TERMINAL SELECTOR is set to 2-TERMINAL X1; otherwise safety diodes will distort the test signal and invalidate the balance condition.

At high settings of GAIN, movement of your hands or other objects near the unshielded 2-TERMINAL UNKNOWN port will upset the balance. Keep hands away and nearby objects still.

a. Install an adaptor on the 2-TERMINAL UNKNOWN port and plug in a 100-k $\Omega$  standard resistor (Table 5-1) as the first G standard.

b. Reset the frequency to 102 Hz, the oscillator level to 10 V, and tune the detector and oscillator to match as before. However, reset the PHASE SHIFT in the process of balancing the bridge, as described in para. 3.5 under Final Balance *Phase Shift/Reset*.

#### NOTE

Reset the phase shift, as required, as you approach balance in any step of the procedure: para. 5.2.5 and 5.2.6.

The need to do so is recognizable when both phase-sensitive meters respond to a change of either C or G lever switches. (The inconvenience of having to reset PHASE SHIFT is to be expected only for precise measurements of very lossy capacitors, not for most measurements.)

c. Set up, in turn, the combination of G standard, TERMINAL SELECTOR setting, and G readout for each of the first 5 rows in Table 5-3. Complete steps d through f for each setup before proceeding to the next.

d. Start with a convenient GAIN setting. Balance the bridge using the C lever switches, increasing the GAIN to the "dB" number tabulated. (Reset PHASE SHIFT as required.)

e. Adjust the SENSITIVITY so that a change of 5 divisions on the QUADRATURE meter corresponds to the percentage change tabulated as "Tolerance". Notice that a

0.1% change is the step from X00 to X01, or X0(-1). Similarly, a 1-% change is from X0 to X1, or X(-1). A 10-% change is from X to 9. Change the GAIN if necessary.

f. Verify that the internal G standard is within specified accuracy. In other words, the QUADRATURE meter should read between the points labeled 25 when the readout is set as tabulated. (The pertinent standards are R1 through R5, in that order.)

#### 5.2.6 Conductance Multipliers.

A procedure very similar to the preceding one is used to check the G multiplier ratios (steps of  $10^{-1}$ ). In this paragraph, the maximum accuracy (0.1%) is required for every step. Unlike the internal G standards, the multipliers can be trimmed by you, the customer, if you find they fail to meet the following specifications (para. 5.4).

a. The setup is much the same as before. Initially, reinstall the 100-k $\Omega$  standard resistor at the 2-TERMINAL port and connect network "A" (see below) to the 3-TERMINAL UNKNOWN port, using shielded patch cords.

b. Networks "A" and "B" are 3-terminal conductance standards that you can assemble in a few minutes. Each is a tee of 3 resistors, Figure 5-1, enclosed in an electric shield. Use a G874-X as an enclosure for each. Measure the resistance of each resistor, after soldering, at room temperature, to an accuracy of  $\pm 0.03\%$ . Use a precision resistance bridge, such as the GR Type 1666. For convenience in making 4-terminal "Kelvin" connections to each resistor at the test fixture of such a bridge, leave the resistor pigtail full length. (After the measurement they can be coiled up for future use or clipped off.)

c. Calculate the 3-terminal conductance of each network you have made, thus:

Table 5-3  
CONDUCTANCE ACCURACY AND MULTIPLIER CHECKS

External Standard	Terminal Selector	CONDUCTANCE			Approx GAIN	Tolerance	Trimmer Resistor
		us	ns	Mul			
100 k $\Omega$	2-TERM X1	X	000.0	1	50 dB	$\pm 0.1\%$	none
100	2-TERM X10	0	X00.0	1	70	0.1	none
100	2-TERM X100	0	0X0.0	1	90	0.1	none
10 M $\Omega$	2-TERM X10	0	00X.0	1	80	2	none
10	2-TERM X100	0	000.X	1	90	10	none
100 k $\Omega$	2-TERM X10	X	000.0	10-1	60 dB	$\pm 0.1\%$	R18
100	2-TERM X100	X	000.0	10-2	70		R19
"A"	3-TERM X1	X	CDE.F	10-3	80		R20
"A"	3-TERM X10	X	CDE.F	10-4	90		R21
"B"	3-TERM X1	X	GHI.J	10-5	110		R22
"B"	3-TERM X10	X	GHI.J	10-6	120		R23

The letters C thru J represent digits calculated as described in paragraph 5.2.6c.

$$G_A = \frac{R_c}{R_a R_b + R_a R_c + R_b R_c} = X.CDEF \times 10^{-3} \mu S;$$

$$G_B = \frac{R_f}{R_d R_e + R_d R_f + R_e R_f} = X.GHIJ \times 10^{-5} \mu S.$$

Here, C, D, . . . J represent numerical digits, of which F and J are insignificant. Notice that X (ten) is the preferred most-significant digit in following procedure. For example, if  $G_A$  is 9.9765 n, express it as X. (-1)765 nS.

d. Set up, in turn, the combinations of G standard, TERMINAL SELECTOR setting, and G readout for each of the last 6 rows in Table 5-3. Complete steps e through g for each setup, before proceeding to the next.

e. Balance the bridge, as before.

f. Adjust the SENSITIVITY as before, for 0.1% change equals 5 divisions.

g. Verify that the most-significant G standard multiplied by the selected G multiplier is within  $\pm 0.1\%$  of its nominal value. In other words, the QUADRATURE meter should read between the points labeled 25 when the readout is set as tabulated.

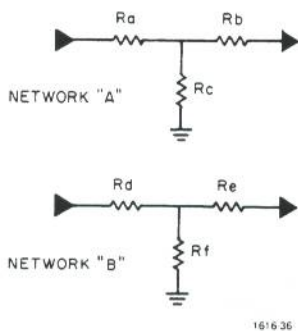

Figure 5-1. Three-terminal conductance standards.  $R_a = R_b = R_d = R_e = 1 \text{ M}\Omega$ .  $R_c = 10.2 \text{ k}\Omega$ .  $R_f = 100 \Omega$ .

## 5.3 DISASSEMBLY.

### 5.3.1 Knobs.



Do not use a screwdriver or other instrument to pry off the knob if it is tight.

To remove the knob from a front-panel control, either to replace one that has been damaged or to replace the associated control, proceed as follows:

a. Grasp the knob firmly with dry fingers close to the panel and pull the knob straight away from panel.

b. Observe the position of setscrew in bushing when the control is fully ccw.

c. Release the setscrew with an Allen wrench; pull the bushing off the shaft.

### NOTE

To separate the bushing from the knob, if for any reason they should be combined off of the shaft, drive a machine tap a turn or two into the bushing to provide sufficient grip for easy separation.

To replace a knob:

a. Slip bushing on shaft and rotate to correct position as observed in disassembly of knob.

b. Keep bushing away from panel by at least the thickness of a filing card. Pull it out farther if necessary to prevent tip of shaft from protruding.

c. Tighten the setscrew in the bushing.

d. Place knob on bushing with retention spring opposite setscrew.

e. Push knob on until it bottoms and pull it lightly, to check that the retention spring is seated in groove in bushing.



### NOTE

Keep POWER OFF during disassembly or re-assembly.

### 5.3.2 Cabinet Removal.

Figure 2-3.

To remove the bench-model cabinet from the bridge, first set the instrument in the horizontal position, free of unnecessary cables, and proceed as follows:

a. Remove the 4 dress-panel screws (A) accessible through holes in the handles.

b. With caution not to let the instrument drop out of its cabinet, turn it face down to rest on the handles.

c. Pull the cabinet up and off. Carefully return the instrument to a horizontal position.

To remove each instrument from the 1621 system cabinet or each rack-mounted instrument from its cabinet, apply step a, above. Then withdraw the instrument forward carefully as described in para. 2.4 and 2.5.

### 5.3.3 C-Box Removal.

Figure 5-2.

The subassembly containing the capacitance standards comprises a substantial part of the instruments' weight and volume. Although it is not to be repaired, it can be removed as follows, either for replacement or for access to miscellaneous wiring.

a. With the bridge right-side-up, outside its cabinet, remove the upper 3 screws (of a total of 5) that are about 1/4 in. from the rear edge of the right side panel.

b. Remove the corresponding 3 from the left. Also on the left side, remove the 3 top screws, 3 more 6 in. below those, and finally 2 more for a total of 11 that form a rectangle.

c. Slide the C box back only 1/4 in., so it has support, and

disconnect the 3 BNC connectors behind the EXTERNAL STANDARD port.

d. Slide the box back about 3½ in. and support it by hand while disconnecting the edge connector from the etched board and the 2 wires that are separately clipped near the middle of the bottom edge of that board.

e. Lift the C box out toward the rear.

f. In reassembly, be sure to bring the C MAX gears into mesh as nearly right as possible. That is, preset the gear on the C box to the ccw position (of 4 detent stops) as seen from the left; preset the C MAX lever down (all 3 windows blanked).

g. Connect the white wire (left) and black (right) first;

then the etched-board connector; then the 3 BNC connectors in this sequence: violet (bottom), gray (middle), red (top).

h. Reposition the idler gear associated with C MAX, necessary, by loosening, moving, and retightening the small recessed screw in the left side panel. Moving it toward the rear decreases the backlash but may cause binding, toward the front makes the action more free.

i. Slip the gear engagement (if the attempt in step f was unsuccessful) as follows. Tip the instrument onto its right side, remove the 11 screws from the left side, and tilt the C box by hand enough to disengage the gears while you move the C MAX lever slightly for better alignment.

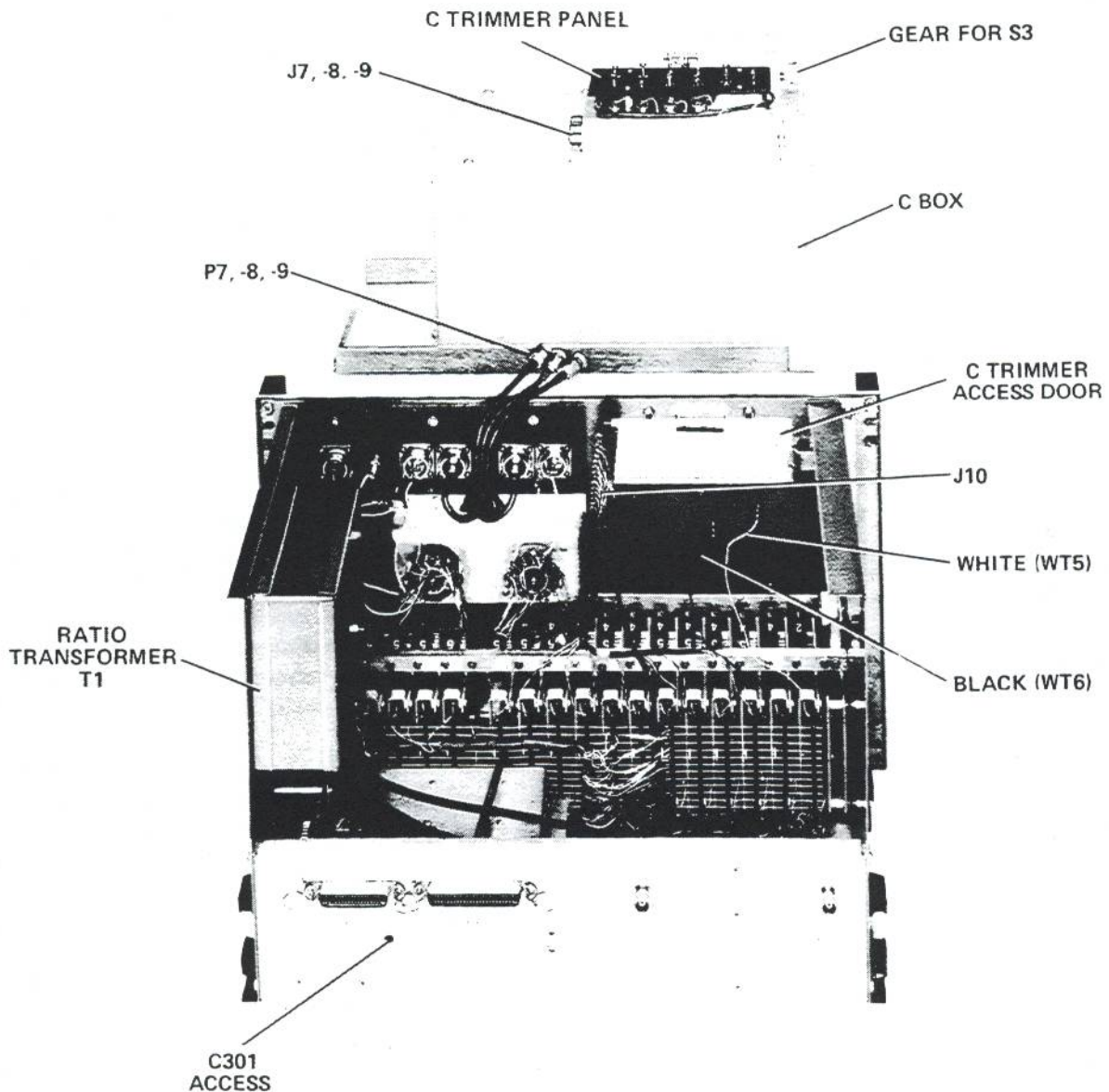

Figure 5-2. Interior view, upper rear, with the C box removed and shown above.



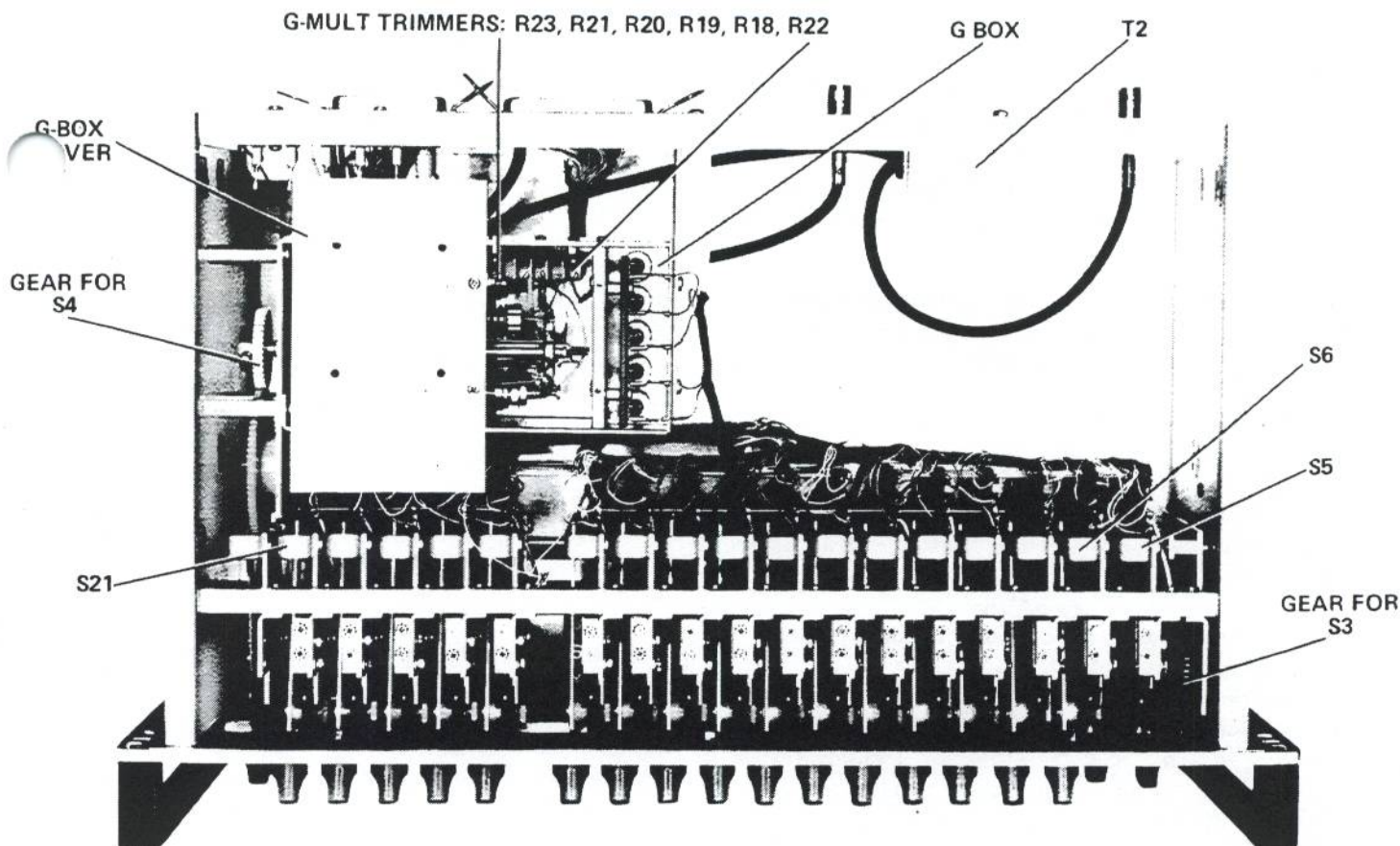

Figure 5-3. Interior bottom view. The G box cover is shown fastened temporarily in position for trimming the G-multiplier network.

### 5.3.4 The G Box.

This "box," containing the conductance standards, is the most conspicuous subassembly in the bottom part of the bridge behind the bank of lever switches. Although the G box is not to be repaired, it can be uncovered for access to the G-multiplier adjustments and it can be removed if necessary. Use this procedure.

- a. Place the bridge upside down.
- b. For access to adjustments, remove the 4 cover screws. Move the cover to the position shown and replace 2 of the screws through the 2 spare holes (nearest the edge) of the cover. Adjust only with the cover attached.
- c. For removal of the box, make a note of the positions of the 10 wires to be disconnected, something like this: left end, front-to-rear: red tracer, green tracer, blue tracer, brown tracer, black tracer; rear panel, left-to-right: red, violet, black, grey, brown.
- d. Disconnect those 10 wires and the yellow-banded BNC connector.
- e. Remove 2 screws in the rear panel (near, but not holding, the BCD CAPACITANCE OUTPUT connector) and 4 screws in the right panel, (among, but not holding, the slide blocks) while holding the G box so it does not fall. Lift it free.
- f. In reassembly, mesh gears properly by presetting the switch on the G box ccw (as seen from the right) and the G

Figure 5-3.

multiplier lever "down," indicating  $10^6$ . If necessary, to obtain proper mesh, try again.

- g. Adjust the gears for a reasonable amount of backlash by moving the G box slightly, while you have the 4 right-side screws temporarily loose.

#### NOTE

Do not reposition or replace any parts or turn any adjustments in the G box except as instructed in para. 5.4. Otherwise  $D_0$  will have to be reset, a factory operation.

### 5.4 RECALIBRATION AND ADJUSTMENTS.

Recalibration is principally the trimming of the internal C standards for absolute accuracy and exact decade ratios. The G multipliers (but not the 5 standards) can be trimmed also. Adjustments include C301 which affects the ZERO ADJUST ranges and mechanical adjustments on the lever switches.

The temperature of the bridge should be maintained well within the allowable tolerance, just as the accuracy of each adjustment should be greater than the acceptable accuracy of the bridge. For example, in addition to the temperature requirements described in para. 5.2, the bridge should be held at  $23^\circ \pm 0.5^\circ\text{C}$  for 6 hours previous to and during recalibration.

For special uses, it is possible to recalibrate the bridge at temperatures other than 23°C. The range of trimming provided for the internal C standards sets the upper and lower limits at about 21° and 26°C, respectively. If you do recalibrate at a nonstandard temperature, be sure to tag the bridge with that information.

#### 5.4.1 Adjustment of Internal Capacitance Standards.

To recalibrate the one or all of the internal capacitance standards, proceed as in paragraphs 5.2.3 and 5.2.4 but make adjustments of the trimmers (listed in Table 5-2) to minimize the errors. Additional procedure is as follows.

a. Unlock and open the panel that covers the trimmer screws (para. 1.3).

b. Obtain a small, sturdy screwdriver with an **insulated handle and shank** (or enclose the shank in a plastic sleeve).



**WARNING**  
Full oscillator voltage appears on the trimmer screws.

c. Notice that each screw is labeled in terms of the effective value obtained when the corresponding lever switch is set to maximum. Thus, the 3rd screw is labeled 1nF; it trims C100 which adds 1000pF to the standard arm when 100pF per step lever is set to X. To trim C100 against the external 1000pF standard (para. 5.2.3) use the nF (or 1000pF) trimmer as indicated in the first line of Table 5-2.

d. To trim a smaller standard against a larger (as in the next 9 rows of Table 5-2) use the trimmer whose labeled value is equal to the capacitance setting. See right-hand column of Table 5-2.

e. To trim a larger standard against a smaller (as in the last 2 rows of Table 5-2), use the trimmer whose labeled value is 10 times the capacitance setting. See right-hand column of Table 5-2.

f. If you are interested in preserving the accuracy as long as possible, guard your bridge against any violent motion. Even the impact of a dangling patch cord swung against the panel will cause measurable changes in calibration (but insignificant compared to the specifications). Close the access door over the C trimmers with care, otherwise it will snap in closing.

#### 5.4.2 Conductance Multipliers.

The G-multiplier calibration is similar to that above. Proceed as in para. 5.2.6 and trim so as to minimize any errors you find. The additional procedure is as follows. (Notice that any possible errors in the 5 G standards, para 5.2.5, must be corrected only by GenRad, which has means for checking and adjusting  $D_0$  at the same time.

a. Gain access to the set of 6 screwdriver adjustments on the G box, as in para. 5.3.4.

b. In turn, make the connections and settings indicated in the last 6 rows of Table 5-3, and as described in paragraph 5.2.6, but instead of determining the error, adjust the trimming resistor listed in the last column for the best null possible. Always adjust these trimmers in the order given (R18 first) because the last three adjustments have some interdependence.

### 5-8 SERVICE & DIAGRAMS

#### 5.4.3 C301 / Setting Zero C.

The ZERO ADJUST control varies  $C_0$ , the capacitance offset, in any position of the TERMINAL SELECTOR / READOUT MULTIPLIER switch. So does the rear-panel screwdriver adjustment C301 (Figure 5-2). Normally, C301 is set so that the 10-turn range of ZERO ADJUST spans conveniently the 3 conditions referred to in para. 5.2.2, which are conditions of  $C_0 = 0$  on CAL and both 3-TERMINAL-UNKNOWN positions. (The 3-TERM LOW connector must be shielded.) The adjustment should be made at 1 kHz.

#### 5.4.4 Lever-Switch Stiffness.

The front-panel lever switches that control C and G digits, i.e., all but the first and last levers, have detent mechanisms that can be adjusted as required. The factory setting is approximately 12 oz (350 grams weight), the force required at the normal finger position to push each switch from step to step (between 0 and 9).

Other settings are possible, to satisfy individual preferences. About 9 oz will provide a light "feel" and enable you to slide each switch up and down with your thumb on the front of the knob, but you need more skill to avoid stopping between detents. About 16 oz will provide a positive detent action that may be preferable if the bridge has many operators, each making relatively few measurements at a time.

Perhaps more important than the absolute stiffness of the detent action is consistency. If one or more of your switches responds differently from the majority it will be an annoyance. Adjust the detent stiffness as follows.

a. Remove the bridge from its cabinet and position the instrument upside down.

b. Determine which construction you have, by reference to Figure 5-4. "A" has 3 screws in a row along the bottom under each detent wheel; the screw farthest from the panel is an adjustment (not locked). "B" has 2 such screws, both locked.

c. If you have "A" construction, turn the adjustment screw, cw to stiffen the detent action, ccw to loosen it.

d. If "B," loosen screws B and C just enough to allow you to move the block that holds the spring. Tilt the block as is required to obtain the desired detent action and tighten the same screws.

#### 5.4.5 Maintenance Note On Switches

Both rotary and lever switches may become noisy or erratic from lack of lubrication. For rotary switches such as the TERMINAL SELECTOR switch and MULTIPLIER switch, use CRAMOLIN R5 oil. For lever switches, such as C and G decades, use LUBRIKO H101 grease. Clean contact area of lever switches with solvent (i.e., FREON TF) before applying a thin film of lubricant.

### 5.5 TROUBLE ANALYSIS.

If the bridge requires service beyond the realm of recalibration and adjustment described above, or the categories

of repair described below, please return the instrument to GenRad. Refer to para. 5.1.

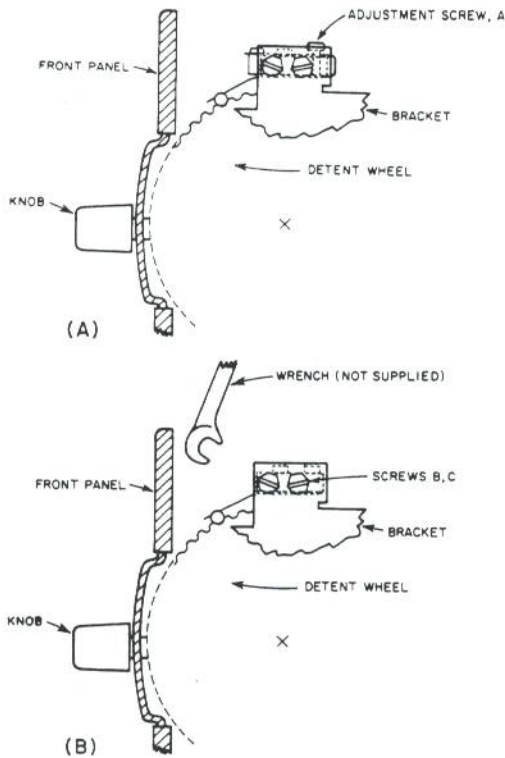

Figure 5-4. Detent mechanism of a typical lever switch, A and B constructions. The instrument is upside down (showing the bottom edge of the front panel). The type of wrench shown in part (B) is recommended for instruments having the B construction.

### 5.5.1 Mechanical Damage.

Parts, such as connectors at front or rear, that are damaged or worn, can be replaced. A wire broken loose can be resoldered or replaced. However, the replacement of any lever switches is *not* recommended. Only the simplest repairs to the mechanisms of the C-MAX or the G-multiplier levers is recommended.

### 5.5.2 BCD circuits.

If the BCD code available at the rear panel does not indicate the measurement as described in para. 2.8, trace the circuit with the help of the schematic diagram, Figure 5-7. If the trouble is in the wiring, repair it. If in the switching, return the instrument to GenRad.

#### NOTE

The lever switches are not replaceable, except by GR.

### 5.5.3 Non-Repairable Subassemblies.

The following components are not to be disassembled for repair: the ratio transformer T1, the coaxial choke T2, the G box, and the C box. In the unusual event that one of them apparently needs replacement, please consult with GenRad or return the instrument as described before.

### 5.5.4 Typical Parameters.

The following parameters are typical. They are listed for reference in trouble shooting. Unless otherwise noted, set the controls as follows:

- TERMINAL SELECTOR – CAL
- EXT MULTIPLIER – 0
- C and G readout – zeros
- C MAX – shutters closed
- G multiplier –  $10^6$

At the GENERATOR INPUT jack: 3.7 H at 100 Hz, 1  $\Omega$  dc, ungrounded. Demagnetize after dc measurement; para. 3.14. Measured series inductance increases with test voltage; may be 5 H at 1 V.

At the EXTERNAL STANDARD port, with EXT MULTIPLIER at 1.0, 3.7 H at 100 Hz, 1  $\Omega$  dc, grounded. Demagnetize as above.

From DETECTOR OUTPUT to EXTERNAL STANDARD LOW, with the EXTERNAL MULTIPLIER set to 1.0, 14 mH (below 1-V test voltage) at 1 kHz;  $R < 1 \Omega$  dc.

### 5.6 PARTS LISTS AND DIAGRAMS.

The following pages contain mechanical and electrical parts lists, schematic diagrams, and supplementary information.

## MECHANICAL PARTS LIST

Qnt	Fig Ref	Description	GR Part No.	Fed Mfg Code	Mfg Part No.	Fed Stock No.
<b>FRONT</b>						
1	1.	Lock with 2 keys.	5605-0100	24655	5605-0100	
2	2.	Handle.	5360-2032	24655	5360-2032	
1	3.	Cabinet gasket.	5331-2220	24655	5331-2220	
1	4.	Bench cabinet assembly; detailed breakdown listed separately.*	4172-4016	24655	4172-4016	
2	5.	Panel locking connector asm., J1,EXTERNAL STANDARD HIGH; J4,3-TERMINAL UNKNOWN HIGH.	0874-4006	24655	0874-4006	
2	6.	Panel locking connector asm., J2, EXTERNAL STANDARD LOW; J3,3-TERMINAL UNKNOWN LOW.	0874-4005	24655	0874-4005	
1	7.	Banana jack, J5, ground connection.	4150-0900	24655	4150-0900	
1	8.	Precision connector, J6, 2-TERMINAL UNKNOWN.	0900-4410	24655	0900-4410	
1	9.	Knob asm., ZERO ADJUST, including: retainer.	5520-5333	24655	5520-5333	
2	10.	Knob asm., TERMINAL SELECTOR; EXT MULTIPLIER, including: retainer.	5500-5321	24655	5500-5321	
19	11.	Knob for CAPACITANCE or CONDUCTANCE lever switch.	5500-5120	24655	5500-5120	
1	12.	Door assembly.	1616-1041	24655	1616-1041	
<b>REAR</b>						
1	1.	Multiple socket, J12, BCD CONDUCTANCE OUTPUT.	4230-4036	93916	57-40360	
1	2.	Multiple socket, J13, BCD CAPACITANCE OUTPUT.	4230-4049	93916	57-40500	5935-062-177
2	3.	BNC connector, J11, GENERATOR OUTPUT; J14, DETECTOR OUTPUT	4230-1200	91836	KC-19-161	
2	4.	Foot (resilient strip).	4171-7010	24655	4171-7010	

### NOTE

Electrical parts information in this section is presented in such a way that all the data for a part-numbered sub-assembly are visible in a single opening of the manual. Thus, the parts list appears on left-hand pages, while the part-location diagram (on the apron) and the schematic diagram (tip out) are on right-hand pages.

\*Cabinet kits and hardware are listed on page 5-12.

### REFERENCE DESIGNATOR ABBREVIATIONS

B = Motor	P = Plug
BT = Battery	Q = Transistor
C = Capacitor	R = Resistor
CR = Diode	S = Switch
DS = Lamp	T = Transformer
F = Fuse	U = Integrated Circuit
J = Jack	VR = Diode, Zener
K = Relay	X = Socket for Plug-In
KL = Relay Coil	Y = Crystal
KS = Relay Switch	Z = Network
L = Inductor	
M = Meter	
MK = Microphone	

References  
ASA Y32.16 and MIL-STD-16C

CONNECTIONS  
 \* OUTPUT LEAVES SUBASSEMBLY  
 - INPUT FROM DIFFERENT SUBASSEMBLY  
 > OUTPUT REMAINS ON SUBASSEMBLY  
 - INPUT FROM SAME SUBASSEMBLY

S4 SEQUENCE  
 (G MULTIPLIER SWITCH SHOWN IN 10<sup>-6</sup> POSITION)

TERMINAL	CODE	10 <sup>-6</sup>	10 <sup>-5</sup>	10 <sup>-4</sup>	10 <sup>-3</sup>	10 <sup>-2</sup>	10 <sup>-1</sup>	1
S4, 105R	1		X		X			X
S4, 108R	2	X			X	X		
S4, 104F	4	X	X	X				
S4, 106R	REF	X	X	X	X	X	X	X

S2 SEQUENCE  
 (TERMINAL SELECTOR SWITCH SHOWN IN 3 TERMINAL X10 POSITION)

TERMINAL	CODE	3 TERMINAL		2 TERMINAL	
		X10	X1	X100	X1
S2, 321R	1	X		X	
S2, 305R	2		X	X	
S2, 306F	4			X	X
S2, 307FR	V REF	X	X	X	X

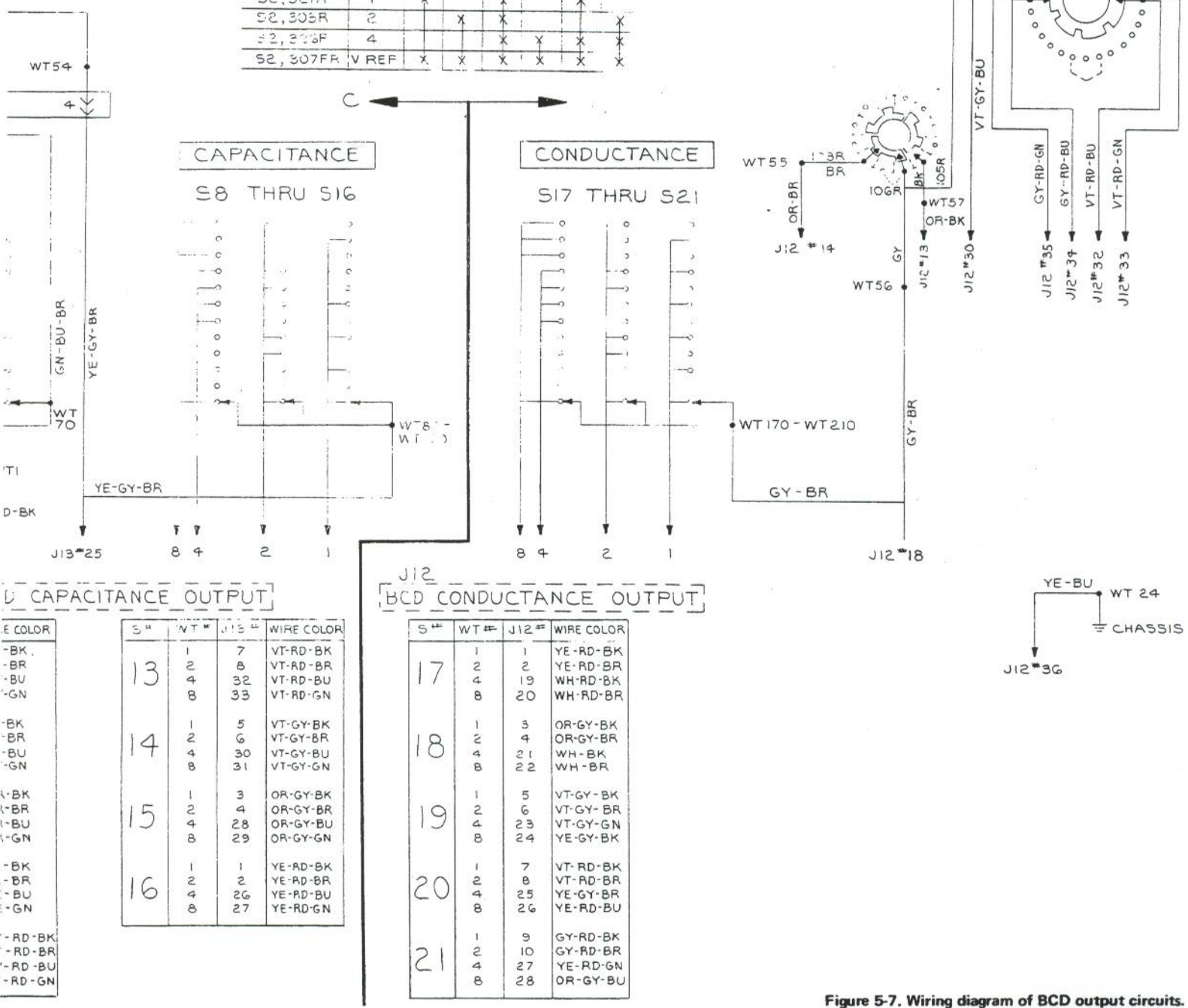

CAPACITANCE OUTPUT

WIRE COLOR	S#	WT#	J12#	WIRE COLOR
-BK	13	1	7	VT-RD-BK
-BR		2	8	VT-RD-BR
-BU		4	32	VT-RD-BU
-GN		8	33	VT-RD-GN
-BK	14	1	5	VT-GY-BK
-BR		2	6	VT-GY-BR
-BU		4	30	VT-GY-BU
-GN		8	31	VT-GY-GN
-BK	15	1	3	OR-GY-BK
-BR		2	4	OR-GY-BR
-BU		4	28	OR-GY-BU
-GN		8	29	OR-GY-GN
-BK	16	1	1	YE-RD-BK
-BR		2	2	YE-RD-BR
-BU		4	26	YE-RD-BU
-GN		8	27	YE-RD-GN

BCD CONDUCTANCE OUTPUT

S#	WT#	J12#	WIRE COLOR
17	1	1	YE-RD-BK
	2	2	YE-RD-BR
	4	19	WH-RD-BK
	8	20	WH-RD-BR
18	1	3	OR-GY-BK
	2	4	OR-GY-BR
	4	21	WH-BK
	8	22	WH-BR
19	1	5	VT-GY-BK
	2	6	VT-GY-BR
	4	23	VT-GY-GN
	8	24	YE-GY-BK
20	1	7	VT-RD-BK
	2	8	VT-RD-BR
	4	25	YE-GY-BR
	8	26	YE-RD-BU
21	1	9	GY-RD-BK
	2	10	GY-RD-BR
	4	27	YE-RD-GN
	8	28	OR-GY-BU

Figure 5-7. Wiring diagram of BCD output circuits.



RESISTANCE IS IN OHMS, K = 10<sup>3</sup>, M = 10<sup>6</sup>  
 CAPACITANCE IS IN FARADS, μ = 10<sup>-6</sup>, p = 10<sup>-12</sup>  
 VOLTAGES EXPLAINED IN INSTRUCTION BOOK SERVICE NOTES  
 ○ = PANEL CONTROL    ⊖ = REAR CONTROL  
 ⊙ = SCREWDRIVER CONTROL    WT = WIRE TIE    TP = TEST POINT  
 COMPLETE REFERENCE DESIGNATION INCLUDES SUBASSEMBLY  
 LETTER, CRT, BR1, ETC.

ROTARY SWITCH NUMBERING  
 WAFER SURFACE, FRONT, REAR  
 CONTACTS    FIRST CONTACT CW  
 FROM STRUT SCREW ABOVE KEY IS 01,  
 SECTION SECTION NEAREST PANEL IS 1  
 ROTORS SHOWN CCW

CONNECTIONS  
 → OUTPUT LEAVES SUBASSEMBLY  
 ⇨ INPUT FROM DIFFERENT SUBASSEMBLY  
 ⇩ INPUT REMAINS ON SUBASSEMBLY  
 ⇧ INPUT FROM SAME SUBASSEMBLY

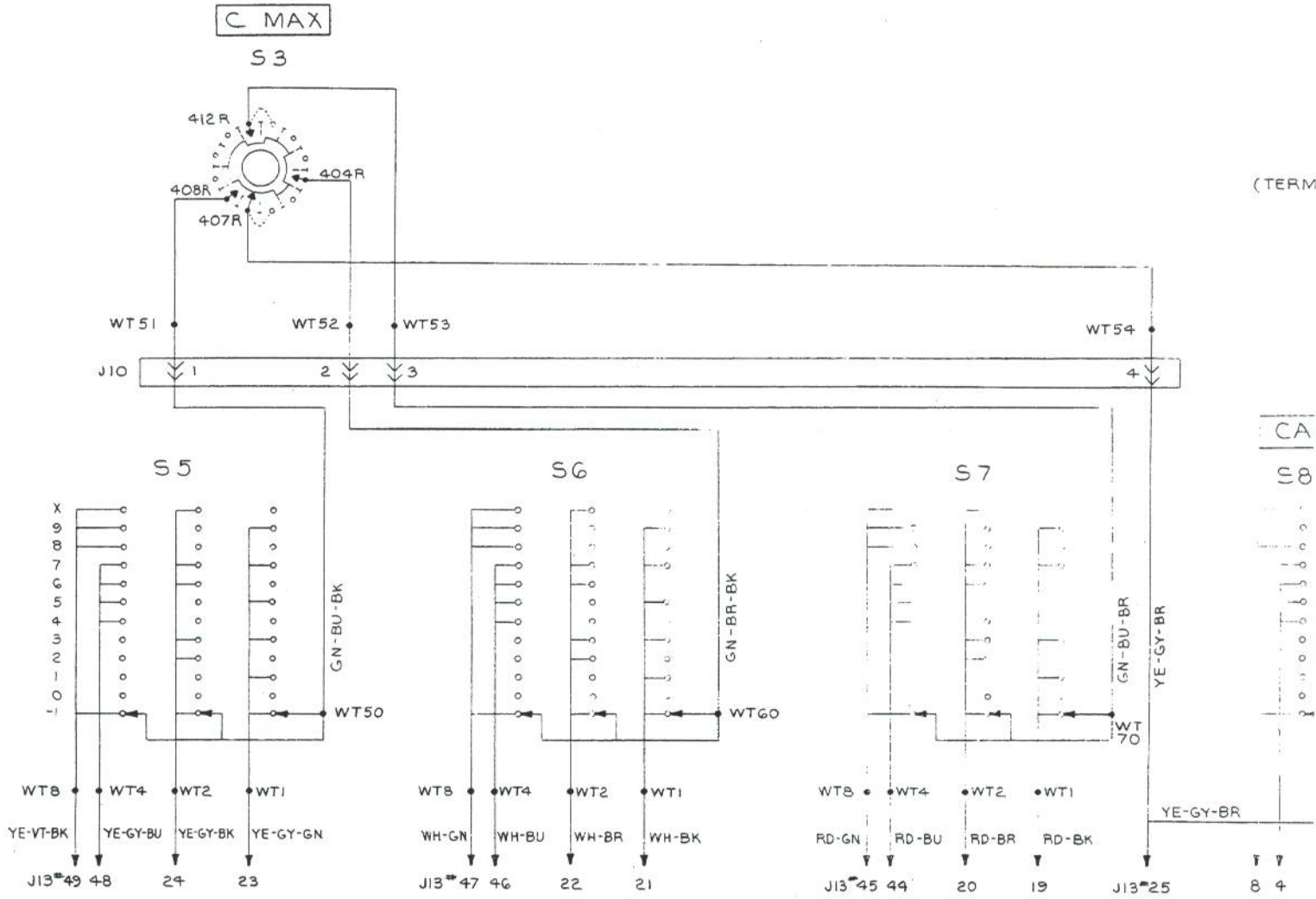

J13 BCU CAPACITANCE OUT

S#	WT#	J13#	WIRE COLOR
8	1	17	GY-BK
	2	18	GY-BR
	4	42	GY-BU
9	1	15	VT-BK
	2	16	VT-BR
	4	40	VT-BU
10	1	13	OR-BK
	2	14	OR-BR
	4	38	OR-BU
11	1	11	YE-BK
	2	12	YE-BR
	4	36	YE-BU
12	1	9	GY-RD-BK
	2	10	GY-RD-BR
	4	34	GY-RD-BU
	8	35	GY-RD-GN

S#	WT#	J13#
13	1	17
	2	18
	4	42
14	1	15
	2	16
	4	40
15	1	13
	2	14
	4	38
16	1	11
	2	12
	4	36

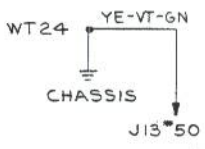





## ELECTRICAL PARTS LIST

CHASSIS MOUNTED PARTS P/N 1616-3000

REFDES	DESCRIPTION	PART NO.	FMC	MFGR	PART NUMBER
C 1	CAPACITOR .09993 UF	0505-4029	24655	0505-4029	
C 2	CAPACITOR 9990 PF	0505-4028	24655	0505-4028	
C 3	FACTORY SELECT	****-****			
C 4	CAPACITOR AIR 3-32PF	4380-3725	74970	160-130	
C 5	FACTORY SELECT	****-****			
C 6	CAPACITOR AIR 1.7-8.7PF	4380-3600	80583	MAC-1J	
C 7	TRIMMER CAPACITOR ASM	1615-2120	24655	1615-2120	
C 8	TRIMMER CAPACITOR ASM	1615-2120	24655	1615-2120	
C 9	TRIMMER CAPACITOR ASM	1615-2110	24655	1615-2110	
C 10	TRIMMER CAPACITOR ASM	1615-2110	24655	1615-2110	
C 11	TRIMMER CAPACITOR ASM	1615-2110	24655	1615-2110	
C 12	TRIMMER CAPACITOR ASM	1615-2110	24655	1615-2110	
C 13	TRIMMER CAPACITOR ASM	1615-2110	24655	1615-2110	
C 14	TRIMMER CAPACITOR ASM	1615-2130	24655	1615-2130	
C 15	TRIMMER CAPACITOR ASM	1615-213J	24655	1615-213J	
C 16	TRIMMER CAPACITOR ASM	1615-2180	24655	1615-2180	
C 17	CAP POLYPROPYLENE 560PF 10PCT 200V	4863-1569	19396	PP481 560PF 10PCT	
C 18	TRIMMER CAPACITOR ASM	1615-2200	24655	1615-2200	
C 20	TRIMMER CAPACITOR ASM	1615-2120	24655	1615-2120	
C 21	TRIMMER CAPACITOR ASM	1615-2110	24655	1615-2110	
C 22	TRIMMER	1616-6600	24655	1616-6600	
C 23	TRIMMER	1616-6600	24655	1616-6600	
C 24	TRIMMER	1616-6600	24655	1616-6600	
C 25	TRIMMER	1616-6600	24655	1616-6600	
C 26	TRIMMER	1616-6600	24655	1616-6600	
C 27	TRIMMER	1616-6600	24655	1616-6600	
C 28	CAP MICA 62 PF 5PCT 500V	4700-0364	81349	CM05ED620 JN	
C 100	CAPACITOR ASM	1616-4810	24655	1616-4810	
C 101	CAPACITOR ASM	1616-4810	24655	1616-4810	
C 102	CAPACITOR ASM	1616-4810	24655	1616-4810	
C 103	CAPACITOR ASM	1616-4810	24655	1616-4810	
C 300	FACTORY ADJUST	****-****			
C 301	TRIMMER CAPACITOR ASM	1615-2130	24655	1615-2130	
** J 1	PANEL CONNECTOR	0874-4006	24655	0874-4006	
** J 2	PANEL CONNECTOR	0874-4005	24655	0874-4005	
** J 3	PANEL CONNECTOR	0874-4005	24655	0874-4005	
** J 4	PANEL CONNECTOR	0874-4006	24655	0874-4006	
J 5	BUSHING THREADED BANANA TURRET	4150-0900	24655	4150-0900	
** J 6	PANEL CONNECTOR	0900-4410	24655	0900-4410	
J 7	RECPT BNC	4230-2300	24655	4230-2300	
J 8	RECPT BNC	4230-2300	24655	4230-2300	
J 9	RECPT BNC	4230-2300	24655	4230-2300	
J 10	CONNECTOR PC 15 POS SR .156 SP	4230-2715	26601	143-015-08	
J 11	RECPT BNC BULKHEAD .206 CABLE	4230-120J	91836	KC-19-161	
J 12	RECPT MICRO RIB 36 CONT	4230-4036	02660	57-40360-9	
J 13	RECPT MICRC RIB 50 CONT	4230-4049	02660	57-40500-4	
J 14	RECPT BNC BULKHEAD .206 CABLE	4230-1200	91836	KC-19-161	
J 15	RECPT BNC	4230-2300	24655	4230-2300	
* R 0	RES CCMP 100 K 5PCT 1/4W	6099-4105	81349	RCR07G104J	
R 1	RES FLM 10K 5/100PCT15PPM1/4W	6619-3450	24655	6619-3450	
R 2	RES FLM 100K 5/100PCT15PPM1/4W	6619-3455	24655	6619-3455	
R 3	RES FLM 1M 1/10PCT 15PPM1/4W	6619-3460	24655	6619-3460	
R 4	RES FLM 10 M 1PCT 100PPM 1/4W	6188-5100	24655	6188-5100	
*** R 5	RES FLM 100 M 1PCT 100PPM 1/4W	6188-6100	24655	6188-6100	
R 6	RES FLM 80K 1/10PCT 15PPM1/4W	6619-3465	24655	6619-3465	
R 7	RES FLM 800K 1/10PCT 15PPM1/4W	6619-3470	24655	6619-3470	
R 8	RES FLM 8 M 1PCT 100PPM 1/4W	6188-4800	24655	6188-4800	
R 9	RES FLM 80 M 1PCT 100PPM 1/4W	6188-5800	24655	6188-5800	
R 24	POT WW KNCB 1K OHM 5 PCT 10T	6060-0142	80294	3540S-1-102	
S 1	SWITCH RECTARY ASM	7890-5338	24655	7890-5338	
S 2	SWITCH RECTARY ASM	7890-5339	24655	7890-5339	
S 3	SWITCH SHIELD	7890-8250	24655	7890-8250	
S 4	SWITCH RECTARY ASM	7890-5337	24655	7890-5337	
S 5	SWITCH ASM	1616-2500	24655	1616-2500	
S 6	SWITCH ASM	1616-2500	24655	1616-2500	
S 7	SWITCH ASM	1616-2500	24655	1616-2500	
S 8	SWITCH ASM	1616-2500	24655	1616-2500	
S 9	SWITCH ASM	1616-2500	24655	1616-2500	
S 10	SWITCH ASM	1616-2500	24655	1616-2500	
S 11	SWITCH ASM	1616-2500	24655	1616-2500	

\* PART OF SWITCH ASM 1616-2500

\*\* SUPPLY AS LOOSE PARTS

\*\*\* ORIENTATION OF PART IS CRITICAL

ELECTRICAL PARTS LIST (cont)

CHASSIS MOUNTED PARTS P/N 1616-3000

REFDES	DESCRIPTION	PART NO.	FMC	MFGR	PART NUMBER
S 12	SWITCH ASM	1616-2500	24655	1616-2500	
S 13	SWITCH ASM	1616-2500	24655	1616-2500	
S 14	SWITCH ASM	1616-2500	24655	1616-2500	
S 15	SWITCH ASM	1616-2500	24655	1616-2500	
S 16	SWITCH ASM	1616-2500	24655	1616-2500	
S 17	SWITCH ASM	1616-2500	24655	1616-2500	
S 18	SWITCH ASM	1616-2500	24655	1616-2500	
S 19	SWITCH ASM	1616-2500	24655	1616-2500	
S 20	SWITCH ASM	1616-2500	24655	1616-2500	
S 21	SWITCH ASM	1616-2500	24655	1616-2500	
T 1	TOROID TRANSFORMER ASM	1616-2310	24655	1616-2310	
T 2	CHOKE ASM	1616-2450	24655	1616-2450	
VR 1	ZENER LMZ-68A 68V 5PCT 1.5W	6083-1064	24444	LMZ-68A 1.5R68B	
VR 2	ZENER LMZ-68A 68V 5PCT 1.5W	6083-1064	24444	LMZ-68A 1.5R68B	

PC BOARD P/N 1616-4720

REFDES	DESCRIPTION	PART NO.	FMC	MFGR	PART NUMBER
R 10	RES FLM 1.02K 1/10 PCT 50PPM1/2W	6193-1000	81349	RN70C1021B	
R 11	RES FLM 100 OHM1/10PCT 50PPM1/8W	6619-1600	24655	6619-1600	
R 12	RES FLM 649K 1 PCT 1/4W	6350-3649	81349	RN60D6493F	
R 13	RES FLM 64.9K 1 PCT 1/4W	6350-2649	81349	RN60D6492F	
R 14	RES FLM 64.9K 1 PCT 1/4W	6350-2649	81349	RN60D6492F	
R 15	RES FLM 64.9K 1 PCT 1/4W	6350-2649	81349	RN60D6492F	
R 16	RES FLM 6.04K 1 PCT 1/8W	6250-1604	81349	RN55D6041F	
R 17	RES FLM 715 OHM 1 PCT 1/8W	6250-0715	81349	RN55D7150F	
R 18	POT CERM TRM 200K OHM 10 PCT 15T	6049-0193	80294	3006P-1-204	
R 19	POT CERM TRM 20K OHM 10 PCT 15T	6049-0190	80294	3006P-1-203	
R 20	POT CERM TRM 20K OHM 10 PCT 15T	6049-0190	80294	3006P-1-203	
R 21	POT CERM TRM 20K OHM 10 PCT 15T	6049-0190	80294	3006P-1-203	
R 22	POT CERM TRM 2K OHM 10 PCT 15T	6049-0187	80294	3006P-1-202	

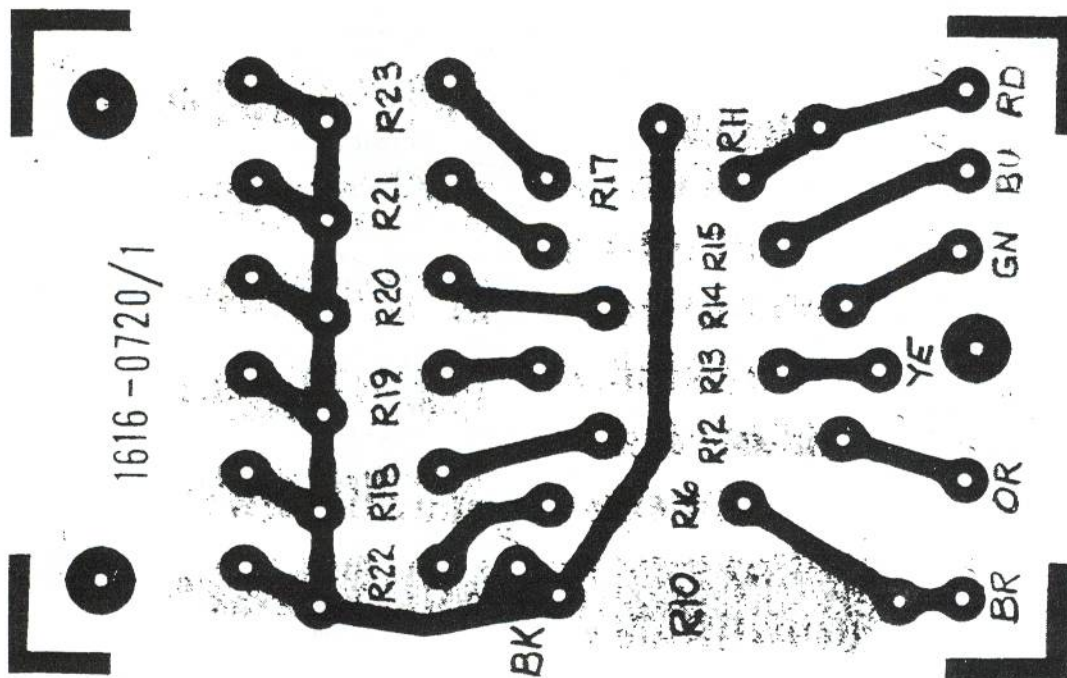

Figure 5-8. Conductance-multiplier board assembly 1616-4720, showing etched circuit.

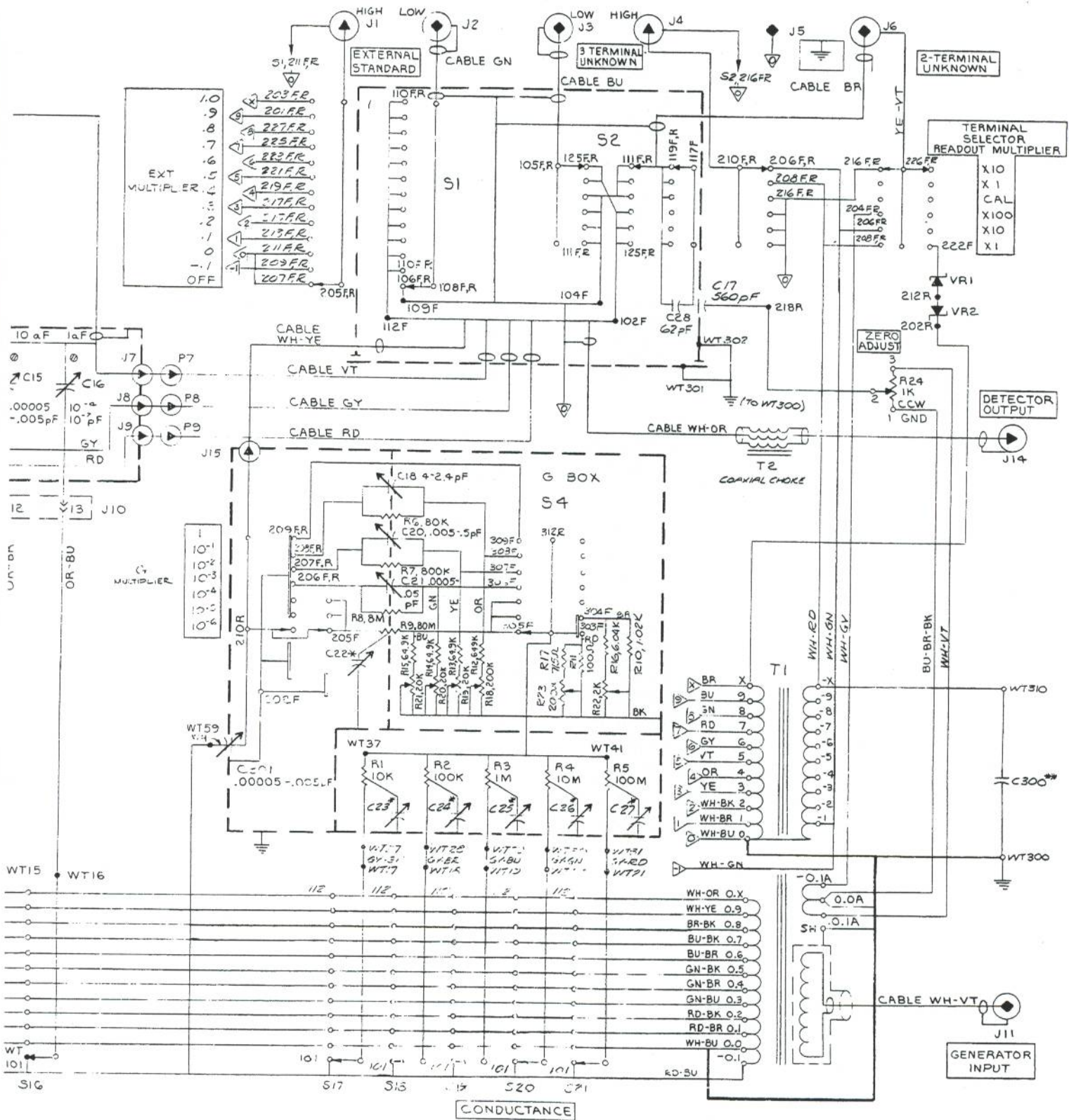
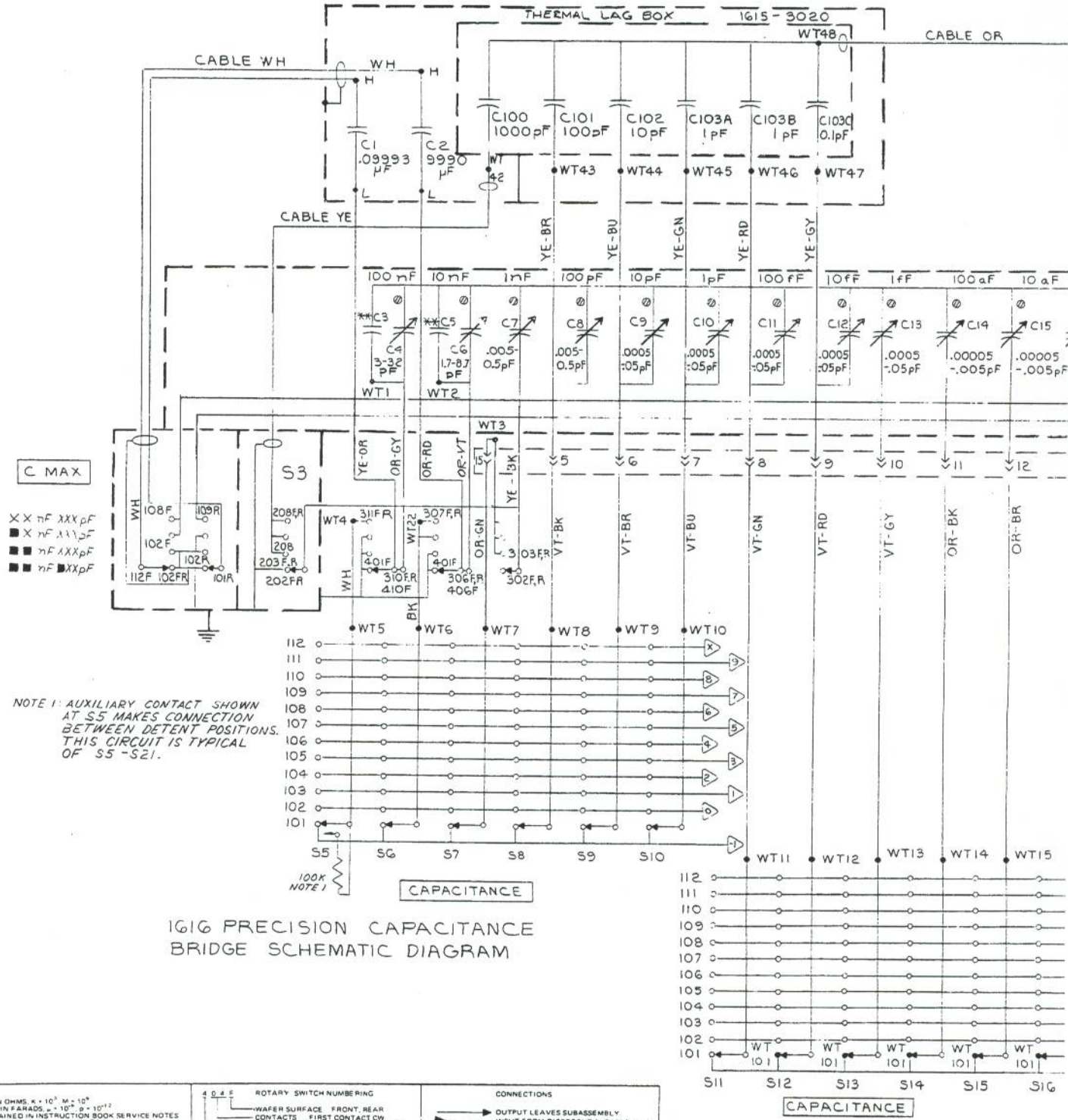

Figure 5-9. Schematic diagram of the 1616 Precision Capacitance Bridge.





NOTE: Orientations of R5, R9, and C17 are significant; properly oriented by factory.



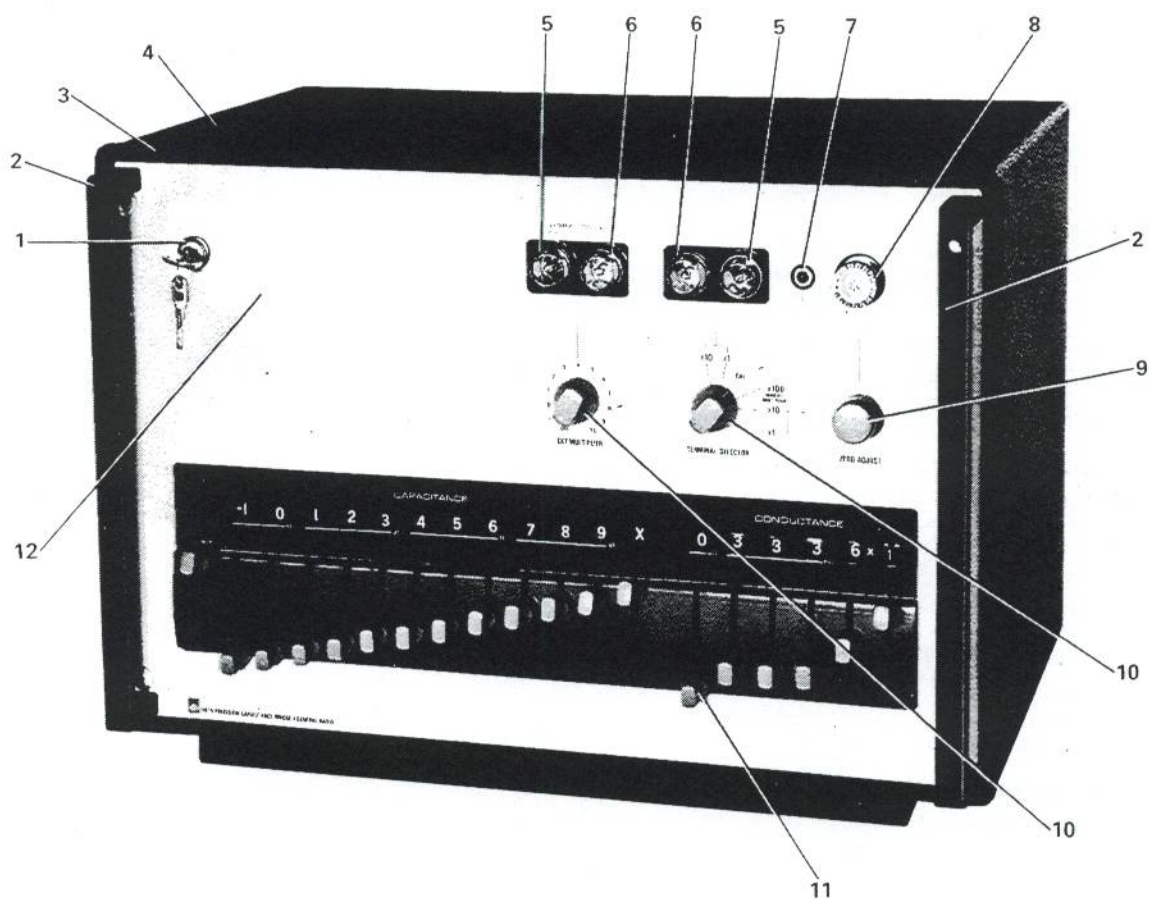

Figure 5-5. Front view; mechanical replaceable parts identified.

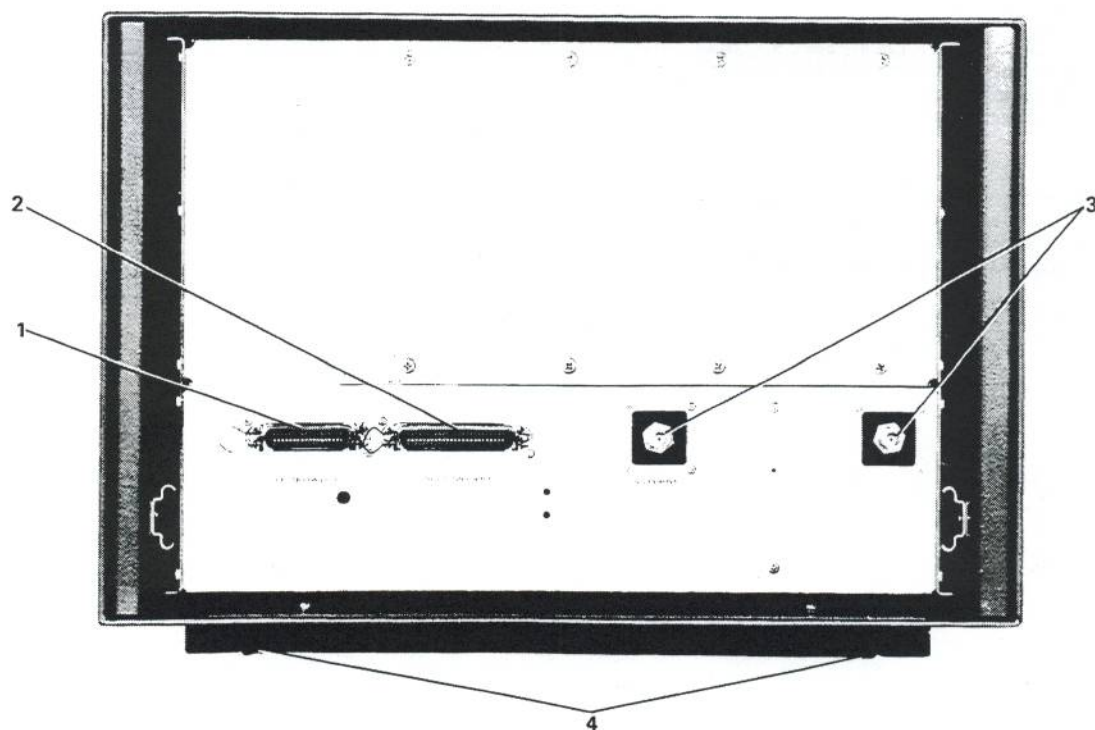

Figure 5-6. Rear view; mechanical replaceable parts

MECHANICAL PARTS LIST

Qty	Description	GR Part No.
	RACK-MOUNTING CABINET KIT FOR 1616 BRIDGE	4174-3627
	Cabinet, factory-assembled, of these parts:	
2	Covers	
2	Side pans	
12	Eyelets, used as rivets	
1	Set of 2 tracks, with rivets.	
	Kit also includes:	
4	Dress-panel screws, 10-32, 9/16 in.	A*
4	Thread-forming screws, 8-32, 1/4 in.	B*
4	Nuts, 10-32, and washers.	
	BRACKET SET FOR 1616 BRIDGE	4174-2007
2	Rear-support brackets	
8	Thread-cutting screws, 10-32, 1/2 in.	C, F*
4	Thread-forming screws, 8-32, 3/16 in.	E*
	BENCH CABINET KIT FOR 1616 BRIDGE	
1	Bench-cabinet assembly including: 1 Cabinet 1 Gasket 1 Base with hardware	
	Factory assembled with:	
2	Tracks	
2	Brackets for rear support; and 8 screws, 8-32, 5/16.	
	Also supplied with:	
4	Dress-panel screws, 10-32, 9/16 in.	A*
4	Thread-forming screws, 8-32, 1/4 in.	B*
	BENCH CABINET KIT FOR 1621 SYSTEM	
1	Bench Cabinet Assembly including: 1 Cabinet 1 Gasket 2 Air filters 1 Base with hardware 1 Set: 2 handles and hardware	
	Factory assembled with:	
2	Dust shelves.	
6	Tracks (horizontal).	
2	12-in. rails (vertical, rear support).	
2	6 3/4-in. rails (vertical, rear support).	
2	3 1/4-in. rails (vertical, rear support).	
1	Nameplate (on base). (and thread-forming screws, 8-32, 5/16 in.)	
	SCREWS	
	Also required with 4177-2621 (not included)	
3	Sets of screws, as below,	
4	dress-panel screws, 10-32, 9/16 in.	A*
4	thread-forming screws, 8-32, 1/4 in.	B*

\*See Figures 2-3, 2-4.



## FEDERAL SUPPLY CODE

## FOR MANUFACTURERS

From Defense Logistics Agency Microfiche

H4-2 SB 708-42 GSA-FSS H4-2

Ref FMC Column

in Parts Lists

Code	Manufacturer	Code	Manufacturer	Code	Manufacturer	Code	Manufacturer
00136	McCov Electrs.,Mt.Holly Sopras,PA 17065	15605	Cutler Hammer,Milwaukee,WI 53202	56289	Soraguc,North Adams,MA 01247	80894	Pure Carbon,St Marys,PA 15857
00192	Jones Hg.,Chicago,IL 60181	15782	Houston Inst.,Bellare,TX 77401	57771	Stimpson,Bayport,NY 11705	81030	Int'l Inst.,Orange,CA 06477
00194	Walco Electrs.,Los Angeles,CA 90018	15801	Fenwal Electrs.,Framingham,MA 01701	58563	Superior Valve,Washington,PA 15301	81073	Grayhill,LaGrange,IL 60525
00327	Welwyn Intnl.,Westlake,OH 44145	15819	Sinclair & Rush,St.Louis,MO 63111	59730	Thomas & Betts,Elizabeth,NJ 07207	81143	Isolanite,Striving,NJ 07980
00434	Schwaber Electrs.,Westbury,NY 11590	16037	Sproue Pine Mica,Sproue Pine,NC 28777	59875	TRW,Cleveland,OH 44117	81312	Winchester,Oakville,CT 06779
00656	Aerovox,New Bedford,MA 02745	16068	Intntl Diode,Jersey City,NJ 07304	60399	Torrington,Torrington,CT 06790	81349	Military Specifications
00779	AMP Inc.,Harrisburg,PA 17105	16139	Omni Spectra,Farmingdale,MI 48024	61007	Towhee,Braintree,MA 02184	81350	Joint Army-Navy Specifications
01009	Alden Products,Brockton,MA 02413	16301	Astrolab,Linden,NJ 07036	61637	Union Carbide,New York,NY 10017	81483	Int'l Rectifier,El Segundo,CA 90245
01121	Allen Bradley,Milwaukee,WI 53204	16352	Codi.,Fairlaw,NJ 07410	61864	United Carr Fast,Boston,MA	81741	Chicago Lock,Chicago,IL 60641
01255	Litton Ind.,Beverly Hills,CA 90213	16485	Sterling Inst.,New Hyde Park,NY 11040	63060	Victoreen,Cleveland,OH 44104	81831	Filtrot,Flushing,NY 11354
01281	TRW,Lawndale,CA 90260	16636	Indiana General,Oglesby,IL 61348	63743	Ward Leonard,Mt.Vernon,NY 10550	81840	Ledex,Dayton,OH 45402
01295	Ti.,Dallas,TX 75222	16758	Delco,Kokomo,IN 46901	65083	Westinghouse,Bloomfield,NJ 07003	81860	Barry Wright,Waterstown,MA 02172
01526	GE.,Waynesboro,VA 22980	16950	Precision Dynamics,Burbank,CA 91504	65092	Weston,Newark,NJ 07114	82219	Sylvania,Emporium,PA 15834
01930	Amercook,Rockford,IL 61101	16952	Amer Micro Devices,Summerville,SC 29483	70106	Acushnet Cap.,New Bedford,MA 02742	82227	No.Amer.Philips,Cheshire,CT 06410
01963	Cherry Electr.,Waukegan,IL 60085	17117	Elctrc Molding,Woonsocket,RI 02895	70109	Adams & Westlake,Elkhart,IN 46514	82273	Int'Pattern & Model,LaPorte,IN 46350
02111	Spectrol Electrs.,City of Industry,CA 91745	17540	Mohawk Spring,Schiller Park,IL 60176	70417	Chrysler,Detroit,MI 48231	82389	Switchcraft,Chicago,IL 60630
02114	Ferrocube,Saugerties,NY 12477	17745	Angstrom Precn.,Hagerstown,MD 21740	70485	Atlantic India Rubber,Chicago,IL 60607	82567	Reeves Hoffman,Carlisle,PA 17013
02606	Fenwall Lab.,Morton Grove,IL 60053	17771	Singer,Somerville,NJ 08876	70663	Ampette,Union City,NJ 07087	82647	Prec Metal Prod.,Stamam,MA 02180
02639	GE.,Schenectady,NY 12307	17850	Zeltek,Concord,CA 94520	70611	Ark-Les Switch,Waterstown,MA 02172	82807	Milwaukee Resistor,Milwaukee,WI 53204
02660	Amphenol,Broadview,IL 60153	17856	Siliconix,Santa Clara,CA 95054	70892	Bead Chain,Bridgeport,CT 06605	82877	Rotron,Woodstock,NY 12498
02735	RCA,Somerville,NJ 08876	18324	Signetics,Sunnyvale,CA 94086	70903	Belden,Chicago,IL 60644	82901	IN General Magnet,Valparaiso,IN 46383
02768	Fasteq.,Desplains,IL 60016	18542	New Prod Eng.,Wabash,IN 46992	71126	Bronson,Beacon Falls,CT 06403	83003	Varo, Garland, TX 75040
03042	Carter Ink.,Cambridge,MA 02142	18677	Scanbe,El Monte,CA 91731	71279	Cambridge Thermicon,Cambridge,MA 02138	83014	Hartwell,Placenta,CA 92670
03508	GE.,Syracuse,NY 13201	18736	Computer Diode,S.Fairlane,NJ 07936	71294	Canfield,Clifton Forge,VA 24422	83033	Missner,Mt Carmel,IL 62863
03550	Vanguard Electrs.,Ingwood,CA 90302	18795	Cycon,Sunnyvale,CA 94086	71400	Bussmann,St.Louis,MO 63107	83088	Carr Fastener,Cambridge,MA 02142
03636	Grayburne,Yonkers,NY 10701	18911	Durant,Watertown,WI 53094	71450	CTS,Elkhart,IN 46514	83156	Victory Eng.,Springfield,IL 07081
03877	Transtron Electrs.,Wakefield,MA 01880	19178	Zero,Monson,MA 01057	71468	Cannon,Los Angeles,CA 90031	83259	Parker Seal,Culver City,CA 90231
03888	KDI Pyrofilm,Whippany,NJ 07981	19209	GE.,Gainesville,FL 32601	71482	Clare,Chicago,IL 60645	83330	H.H.Smith,Brooklyn,NY 11207
03911	Claiex,New York,NY 10001	19373	Eastron,Haverhill,MA 01830	71590	Centralab,Milwaukee,WI 53212	83361	Bearing Spctry,San Francisco,CA
04009	Arad Hort.,Hartford,CT 06106	19396	Paktron,Virna,VA 22180	71666	Continental Carbon,New York,NY	83587	Solar Electr.,Warren,PA 16385
04643	Digitronics,Alberton,NY 11507	19617	Cabtron,Chicago,IL 60622	71707	Coto Coil,Providence,RI 02905	83594	Burroughs,Plainfield,NJ 07061
04713	Motorola,Phoenix,AZ 85008	19644	LRC Electrs.,Horsheshoe,NY 14845	71729	Crescent Box,Philadelphia,PA 19134	83740	Union Carbide,New York,NY 10017
04919	Component Mfg.,W.Bridgewater,MA 02379	19701	Electra,Independence,KS 67301	71744	Chicago Min Lamp,Chicago,IL 60640	83766	Mass Engr.,Quincy,MA 02171
05079	Tamstort Electrs.,Bennington,VT 05201	20093	Elect Inds.,Murray Hill,NJ 07974	71823	Cinch,Chicago,IL 60624	83781	National Electrs.,Geneva,IL 60134
05245	Corcom,Chicago,IL 60639	20754	KMC,Long Valley,NJ 07853	71823	Darnell,Downey,CA 90241	84411	TRW,Ogallala,NE 68153
05276	ITT Electrs.,Pomona,CA 91766	21335	Fafnir Bearing.,New Britain,CT 06050	72136	Electromotive,Williamstic,CT 06226	84825	Lehigh Metals,Cambridge,MA 02140
05402	Controls Co.of Amer.,Melrose Pk,IL 60160	21688	Raytheon,Norwood,MA 02062	72228	Continental Screw,New Bedford,MA 02742	84970	Sarkes Tarzan,Bloomington,IN 47401
05574	Viking Inds.,Chatsworth,CA 91311	21759	Lenox Fugie,Watchung,NJ 07060	72259	Nytronics,Berkeley Hts,NJ 07922	84971	Ta Mfg.,Los Angeles,CA 90039
05624	Barber Colman,Rockford,IL 61101	22526	Berg Electrs.,New Cumberland,PA 17070	72619	Dialight,Brooklyn,NY 11237	85604	Keppo,Flushing,NY 11352
05748	Barnes Mfg.,Manfield,OH 44901	22589	Electro Space Fabrctrs.,Topton,PA 19562	72699	General Int.,Newark,NJ 07104	86420	Johnson Casters,Gurnee,IL 60031
05820	Wakefield Eng.,Wakefield,MA 01880	22753	UID Electcs.,Holtsville,FL 33022	72753	Drake,Chicago,IL 60631	86429	Prec Metal Prod.,Stamam,MA 02180
06383	Packit,Trinley Pk,IL 60477	23238	Wavetek,San Diego,CA 92112	72794	Dus Fastener,W.Jsail,NY 11795	86684	RCA,Harrison,NJ 07029
06406	Truelove & Maclean,Waterbury,CT 06708	23342	Avnet Electrs.,Franklin Park,IL 60131	72825	Eby,Philadelphia,PA 19144	86887	REC,New Rochelle,NY 10801
06665	Precision Monolith,Santa Clara,CA 95050	23936	Pamotor,Bulingham,CA 94010	72962	Elastic Stop Nut,Union,NJ 07083	86800	Cont Electrs.,Brooklyn,NY 11222
06743	Clevite,Cleveland,OH 44110	24351	Indiana GnrI Electrc.,Keesby,NJ 08832	72982	Erie,Erie,PA 16512	88140	Cutter Hammer,Lincoln,IL 62656
06795	WLS Stamp,Cleveland,OH 44104	24355	Omni Devices,Cambridge,MA 02142	73445	Amperex Electrs.,Hicksville,NY 11801	88204	GTE Sylvania,Ipswich,MA 01938
06915	Richo Plstc.,Chicago,IL 60646	24444	General Semicond.,Tempe,AZ 85281	73559	Carling Electr.,Hartford,CT 06110	88219	Gould Nat Battery,Trenton,NJ 08607
06928	Teledyne Kntcs.,Soland Bch,CA 92075	24446	GE.,Schenectady,NY 12305	73680	Elco Resistor,New York,NY	88419	Cornell Dubilier,Fuquay Varina,NC 27526
06978	Aladdin Electrs.,Nashville,TN 37210	24454	GE.,Syracuse,NY 13201	73803	Ti.,Attleboro,MA 02703	88627	K&G Mfr.,New York,NY
07047	Ross Milton,Souhampton,PA 18966	24455	GE.,Cleveland,OH 44112	73899	JFD Electrs.,Brooklyn,NY 11219	89285	Potter & Brumfield,Princeton,IN 47871
7126	Digitrol,Paaden,CA 91105	24602	EMC Technlgy.,Cherry Hill,NJ 08034	73917	Groov-Pin,Ridgfield,IL 07657	89482	United Transformer,Chicago,IL
7127	Eagle Signal,Baraboo,WI 53913	24655	Gen Rad,Concord,CA 01742	74193	Quam Nichols,Chicago,IL 60637	89870	Berkshire Fabricator,Kent,CT 06757
72323	Cinch Graphik.,City of Industry,CA 91744	24759	Lenox Fugie,S.Plainfield,NJ 07080	74199	Holo-Krome,Hartford,CT 06110	90201	Malloy Cap.,Indianapolis,IN 46206
07261	Avnet,Culver City,CA 90230	25008	Vacutie,Berkeley,CA 94710	74445	Hubbell,Stratford,CT 06497	90303	Malloy Bat.,Tarrytown,NY 10591
07263	Fairchild,Mountain View,CA 94040	25289	EG&G,Bedford,MA 01730	74455	Industrial Cndnsr.,Chicago,IL 60618	90634	Gulton Inds.,Metuchen,NJ 08840
07387	Birtcher,N.Los Angeles,CA 90032	26601	Tr-County Tube,Nunda,NY 14517	74466	Amphenol,Danbury,CT 06810	90750	Westinghouse,Boston,MA 02118
07595	Amer.Semicond.,Arlington Hts,IL 60004	26805	American Zettler,Costa Mesa,CA 92626	74970	Johnson,Wasaca,MN 56093	90952	Hardware Prod.,Reading,PA 19602
07699	Magnetic Core,Newburgh,NY 12550	27014	National,Santa Clara,CA 95051	75042	IRTCR(W),Burlington,IA 52601	91032	Continental Wire,Reading,PA 17405
07707	USM Fastener,Shelton,CT 06484	27545	Hartford Universal Bat.,Rocky Hill,CT 06067	75376	Kurz-Kasch,Dayton,OH 45401	91146	Cannon,Salem,MA 01970
07828	Bodine,Bridgeport,CT 06605	28480	HP.,Palo Alto,CA 94304	75382	Kuka,Mt Vernon,NY 10551	91210	Gerber,Mishawaka,IN 46544
07829	Bodine Electr.,Chicago,IL 60618	28520	Heyman Mfg.,Kenilworth,NJ 07033	75491	Lafayette,Syosset,NY 11791	91293	Johnson,Spooner,IL 60705
07910	Cont Device,Hawthorne,CA 90250	28975	IMC Magnetics,Roschester,NH 03867	75608	Linde,Providence,RI 02903	91417	Harris,Melbourne,FL 32901
07983	State Labs.,New York,NY 10003	28959	Hoffman Electrs.,El Menna,CA 91734	75915	Litalfuxe,Des Plains,IL 60016	91506	Augat Bros.,Attleboro,MA 02703
07999	Borg Int.,Delavan,WI 53115	30043	Solid State Devices,LaMirada,CA 90638	76005	Lord Mfg.,Erie,PA 16512	91598	Chandler,Wethersfield,CT 06109
08524	Deutsch Fastener,Los Angeles,CA 90045	30646	Beckman Inst.,Cedar Grove,NJ 07009	76149	Malloy Electr.,Detroit,MI 48204	91637	Dale Electcs.,Columbus,NE 68601
08556	Bell Electr.,Chicago,IL 60632	30874	IBM,Armonk,NY 10504	76241	Maurey,Chicago,IL 60616	91662	Elec.,Willow Grove,PA 19090
08730	Vermaline Prod.,Franklin Lakes,NJ 07417	30985	Permag Magnetics,Toledo,OH 43609	76385	3 M Co.,St.Paul,MN 55101	91719	General Inst.,Dallas,TX 75222
09213	GE.,Buffalo,NY 14220	31019	Solid State Sctcfc.,Montgomeryville,PA 18936	76487	Minor Rubber,Bloomfield,NJ 07003	91836	Kings Electcs.,Tuckahoe,NY 11223
09353	C&K Components,Watertown,MA 02172	31514	Standfote Appld Engs.,Costa Mesa,CA 92626	76545	Millen,Malden,MA 02148	91916	Mephisto Tool,Hudson,NY 12534
09408	Star-Tronics,Georgetown,MA 01830	31814	Analogic,Wakefield,MA 01880	76584	Mueller Electr.,Cleveland,OH 44114	91929	Honeywell,Freeport,IL 61032
09823	Burgess Battery,Freeport,IL 61032	31951	Trindge,Pittsburgh,PA 15231	76684	National Tube,Pittsburg,PA	92519	Electra Intsl.,Woodside,NY 11377
09856	Fenwal Electrs.,Framingham,MA 01701	32001	Jensen,Chicago,IL 60638	76854	Oak Inds.,Crystal Lake,IL 60014	92678	Egerton Gennetech,Boston,MA 02115
09922	Burnod,Norwalk,CT 06852	32975	Spectrum Control,Fairview,PA 16415	77127	Linde,Providence,RI 02903	92702	IMC Magnetics,Western,NY 11591
10025	Glassco,Concord,MA 01706	33173	GE.,Owensboro,KY 42301	77147	Paton MacGyver,Providence,RI 02905	92739	Amex.,Redwood City,CA 94063
10389	Chicago Switch,Chicago,IL 60647	34141	Koehler,Marlboro,MA 01752	77166	Pae Seymour,Syracuse,NY 13209	92966	Hudson Lamp,Keamyn,NJ 07032
11236	Chd of Berne,Berne,IN 46711	34156	Semicond.,Costa Mesa,CA 92626	77263	Pierce Roberts Rubber,Trenton,NJ 08638	93332	Sylvania,Woburn,MA 01801
11599	Candler Evans,W.Hartford,CT 06101	34333	Silicon Genrl.,Westminster,CA 92683	77315	Platt Bros.,Waterbury,CT 06720	93346	Amer Electcs Labs.,Lansdale,PA 19446
11983	Nortronics,Minneapolis,MN 55427	34335	Advanced Micro Devices,Sunnyvale,CA 94086	77339	Positive Lockwasher,Newark,NJ	93618	R&C Mfg.,Ramsay,PA 16671
12040	National,Santa Clara,CA 95051	34649	Intel,Santa Clara,CA 95051	77342	AMF.,Princeton,IN 47570	93916	Cramer,New York,NY 10013
12045	Elctrc Transistors,Flushing,NY 11354	34677	Solitron Devices,Jupiter,FL 33458	77542	Ray-o-Vac,Madison,WI 53703	94144	Raytheon,Quincy,MA 02169
12498	Teledyne,Mountain View,CA 94043	35219	Constanta,Montréal,QUE,CAN	77630	TRW,Camden,NJ 08103	94154	Wagner Electr.,Livingston,NJ 07039
12672	RCA.,Woodbridge,NJ 07095	36482	National Ltd.,Montréal,QUE,CAN	77638	General Int.,Brooklyn,NY 11211	94271	Weston,Archibald,PA 18403
12687	Claroast,Dover,NH 03820	37942	Mallory,Indianapolis,IN 46206	78189	Shakeproof,Elgin,IL 60120	94322	Tel Labs.,Manchester,NH 03102
12856	Micrometals,City of Industry,CA 91744	38443	Marlin Rockwell,Jamestown,NY 14701	78277	Sigma Inst.,Branford,CT 06720	94589	Dickson,Chicago,IL 60619
12954	Dickson Electrs.,Sophtdale,AZ 85252	39317	McGill Mfg.,Valdais,IN 46383	78429	Airco Soper,St Marys,PA 15867	94696	Magnecraft,Chicago,IL 60630
12969	Unitrade,Waterstown,MA 02172	40931	Howellwell,Minneapolis,MN 55408	78488	Stackpole,St Marys,PA 15867	94800	Atlas Ind.,Brookline,NH 03033
13094	Electrocraft,Hopkint,MN 55343	42190	Muter,Chicago,IL 60638	78553	Tinnerman,Cleveland,OH	95076	Garde,Cumference,RI 02864
13103	Thermalloy,Dalits,TX 75234	42498	National,Melrose,MA 02176	78711	Telephonics,Huntington,NY 11743	95121	Quality Comp.,St Marys,PA 15857
13148	Vogue Inst.,Richmond Hill,NY 11418	43334	New Departure-Hyatt,Sandusky,OH 44870	79089	RCA.,Harrison,NJ 07029	95146	Alec Electcs.,Lawrence,MA 01843
13150	Vernitron,Laconia,NH 03246	43991	Norma Hoffman,Stanford,CT 06904	79136	Waldes Kohinor.,New York,NY 11101	95238	Continental Conn.,Woodside,NY 11377
13327	Solitron Devices,Tappan,NY 10983	49671	RCA.,New York,NY 10020	79397	Western Rubber.,Goshen,IN 46526	95275	Vitramon,Bridgeport,CT 06601
13715	Fairchild,San Rafael,CA 94903	49956	Raytheon,Waltham,MA 02154	79725	Wiremold,Hartford,CT 06110	95348	Gordos,Bloomfust,IL 07003
13819	Burr Brown,Tucson,AZ 85706	50088	Mostek,Carrollton,TX 75006	79727	Continental Wire,Philadelphia,PA 19101	95354	Method,Rome Meadow,IL 60008
14010	Analex Inst.,Van Nuys,CA 91406	50101	GHZ Devices,S.Chelmsford,MA 01824	79840	Mallory Controls,Frankfort,IN 46041	95794	Amer Brass,Torrington,CT 06790
14195	Elctrc Controls,Wilton,CT 06897	50507	Micro Networks,Worcester,MA 01606	79963	Zierick,Mt Kisco,NY 10549	95887	Weckover,Chicago,IL 60646
14196	American Labs.,Fullerton,CA 92634	50622	Monsanto,Palo Alto,CA 94304	80009	Tektronix,Beaverton,OR 97005	96095	Aerovox H.,Co.,Dlean,NY 14780
14332	Relton,Arcadia,CA 91006	50721	Datel Systems,Canton,MA 02021	80030	Prestole Fastener,Toledo,OH 43605	96341	Microwave Assoc.,Burlington,MA 01801
14433	ITT,W.Palm Beach,FL 33402	51167	Aries Electcs.,Frenchtown,NJ 08825	80048	Vickers,St Louis,MO 63166	96906	Military Standards
14482	Watkins & Johnson,Palo Alto,CA 94304	51553	Diablo Systems,Hayward,CA 94545	80103	Lambda,Melville,NY 11746	97181	Linemaster Switch,Woodstock,CT 06281
14608	Corbin,Berlin,CT 06037	51642	Centre Eng.,State College,PA 16801	80183	Sprague,N.Adams,MA 01247	98291	Sealester,Mamaroneck,NY 10544
14655	Cornell Dubilier,Newak,NJ 07101	52648	Plessev,Santa				

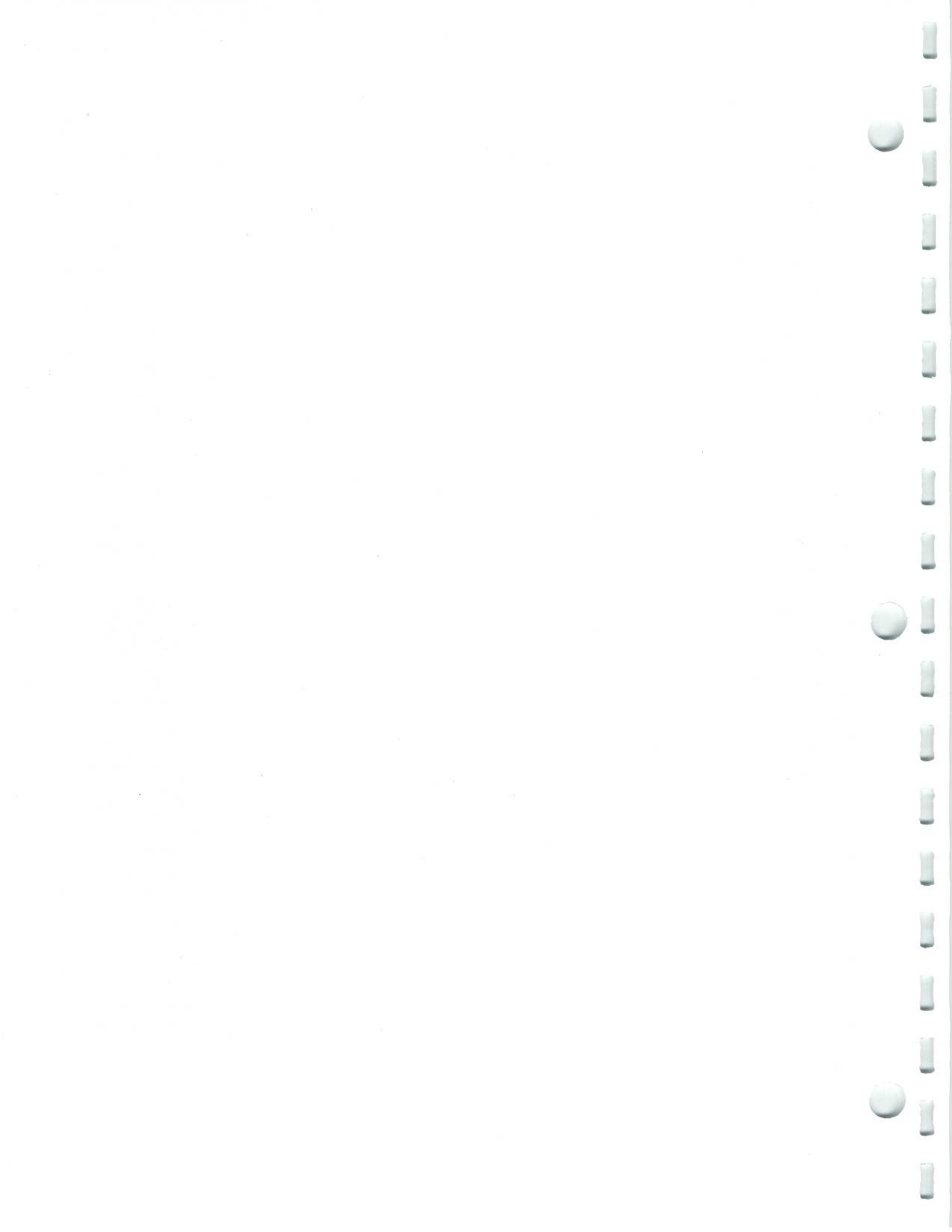

# Appendix A

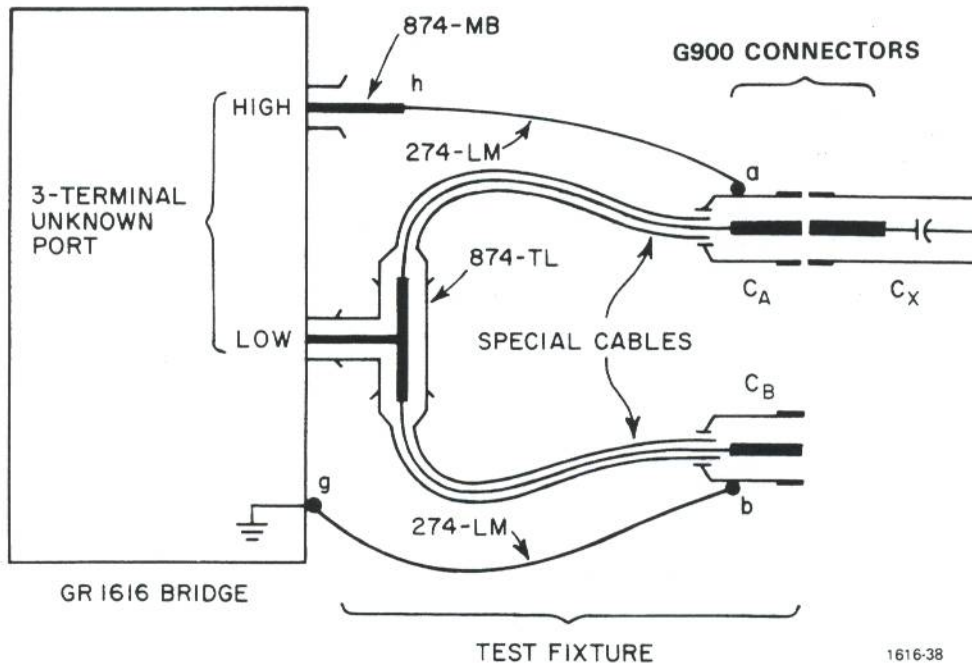

Figure A-1. Test setup for 2-terminal measurement, with fringing eliminated.

1616-38

## Appendix A

### An Interpretation of Millea's Method\* to Eliminate Fringing from Two-Terminal Measurement.

If a suitable 2-terminal standard is not available, and the uncertainty of  $\pm 0.08$  pF in the fringing of the G900 connector is unacceptable for your measurements, this method is recommended. (Refer to para. 3.9.)

**Test Fixture.** The assembly of adaptor, tee, cables, and wires is shown in Figure 1. The special cables (2 required) are not commercially available, but may be constructed as follows.

a. Remove the G874 connector from one end of a Type 874-R22LA Patch Cord.

b. Install a G900 cable connector instead, Type 900-C58, but do not connect its outer conductor to the cable shield. Leave a gap as shown, by cutting the shield braid back as far as the cable jacket. Touch the cut ends of the braid back under the jacket enough to assure insulation. The two should not be cut so short as to expose the inner conductor to external fields. The rubber sleeve should provide some strain relief and the cable retainer (by overlapping the shielded portion of the cable) sufficient shielding. It is imperative that the inner conductor of the connector be rigidly supported so that  $C_A$  and  $C_B$  are constants.

c. Provide a terminal for connecting a wire (274-LM) to the outer conductor or each G900 connector (points a, b).

**Working Capacitor.** Use a 2-terminal coaxial capacitor with a G900 connector. This is  $C_X$ ; it may be your unknown capacitor or one you wish to calibrate as a standard.

#### Procedure.

a. With the connections as shown, i.e.,  $C_X$  connected to  $C_A$ , a to h, and b to g, measure:  $C_1 = C_A + C_X$ .

b. With the working capacitor transferred to the other arm of the fixture, i.e.,  $C_X$  connected to  $C_B$ , b to h, and a to g, measure:  $C_2 = C_B + C_X$ .

c. With the fixture closed on itself, i.e.,  $C_A$  connected to  $C_B$ , a or b to h (neither to g), measure  $C_3 = C_A + C_B$ .

d. Calculate the capacitance without fringing:  $C_X = (C_1 + C_2 - C_3) / 2$ .

\*Millea, Aurel, "Connector Pair Techniques for the Accurate Measurement of Two-Terminal Low-Value Capacitances," Journal of Research, 3, of the National Bureau of Standards, Vol 74C, Nos 3 & 4, July-Dec., 1970.

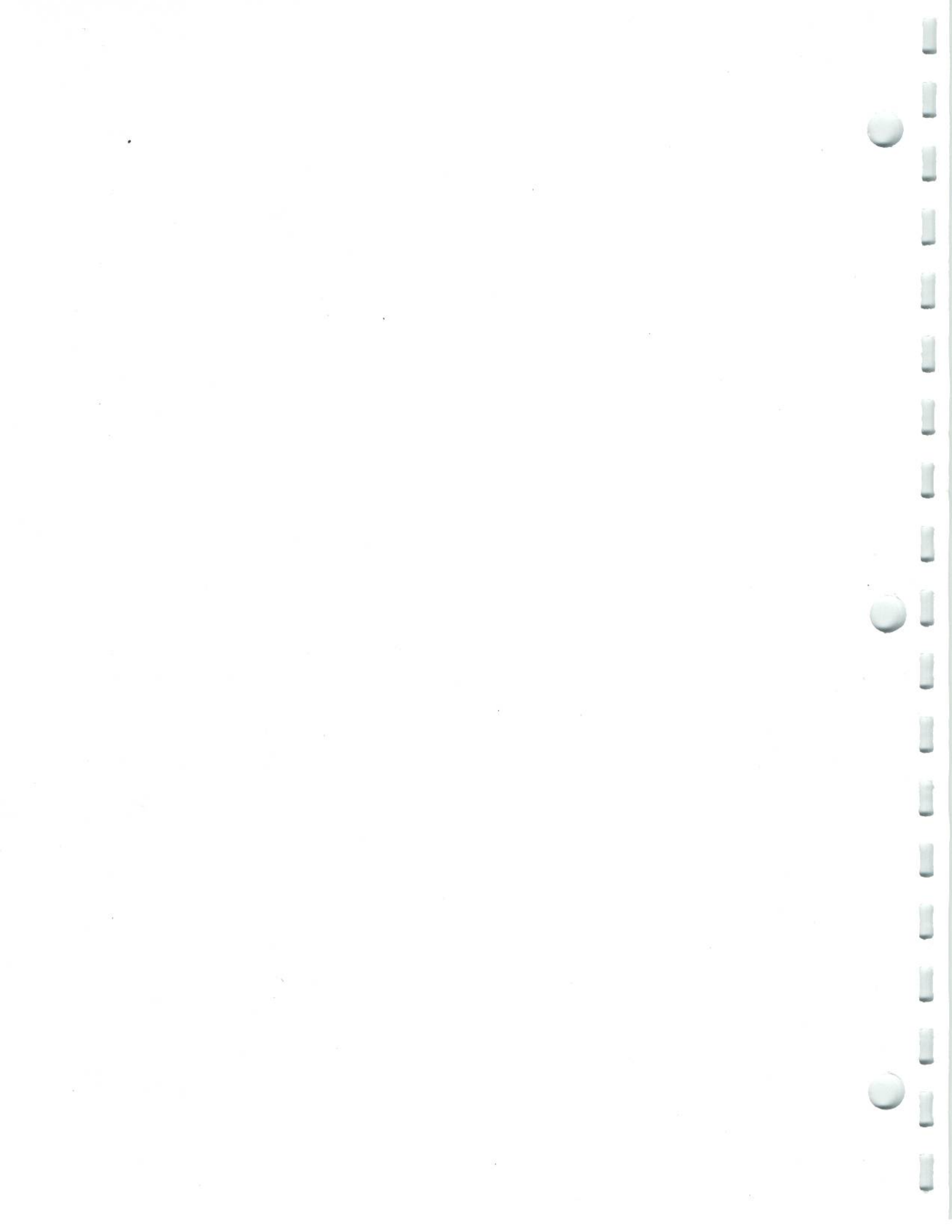



---

**IET LABS, INC.**

**Standards • Decades • Strokes • Sound Level Meters • Bridges**

Formerly manufactured by

**GenRad**

534 Main Street, Westbury, NY 11590

TEL: (516) 334-5959 • (800) 899-8438 • FAX: (516) 334-5988

[www.ietlabs.com](http://www.ietlabs.com)

